

Lenovo ThinkSystem SN550 Server (Xeon SP Gen 2) Product Guide

The Lenovo ThinkSystem SN550 is a high-performance server that offers enhanced security, efficiency, and reliability features to handle business-critical workloads. The blade server incorporates up to two second-generation Intel Xeon Scalable processors. The processors feature up to 28 cores each and use Lenovo TruDDR4 memory, which runs at speeds up to 2933 MHz.

Suggested uses: database, virtualization, enterprise applications, collaboration and email, streaming media, Web, HPC, and cloud applications.

Figure 1 shows the ThinkSystem SN550 server.



Figure 1. ThinkSystem SN550 server

Did you know?

The SN550 server uses the new second-generation Intel Xeon Scalable Bronze, Silver, Gold and Platinum processors and memory can now operate at speeds up to 2933 MHz. It also includes the UEFI-based Lenovo XClarity Provisioning Manager for rapid system setup and diagnosis, and Lenovo XClarity Controller management processor for systems management and alerting.

Key features

The ThinkSystem SN550 is a high-availability, scalable blade server that is optimized to support the next-generation microprocessor technology. It is ideally suited for medium and large businesses. This section describes the key features of the server.

Scalability and performance

The SN550 offers the following features to boost performance, improve scalability, and reduce costs:

- Up to 14 SN550 servers can be installed in one Flex System Enterprise chassis.
- Supports second-generation Intel Xeon Processor Scalable processors
- Improves productivity by offering superior system performance with two processors, each up to 28 cores or up to 3.8 GHz core frequency, and supporting a processor Thermal Design Power (TDP) rating of up to 165W.
- Supports up to two processors, 52 cores, and 104 threads, which maximizes the concurrent execution of multi-threaded applications.
- Intelligent and adaptive system performance with energy-efficient Intel Turbo Boost Technology allows CPU cores to run at maximum speeds during peak workloads by temporarily going beyond processor TDP.
- Intel Hyper-Threading Technology boosts performance for multithreaded applications by enabling simultaneous multithreading within each processor core, up to two threads per core.
- Intel Virtualization Technology integrates hardware-level virtualization hooks that allow operating system vendors to better use the hardware for virtualization workloads.
- Intel Speed Select Technology provides improvements in server utilization and guaranteed per-core performance service levels with more granular control over processor performance.
- Intel Deep Learning Boost (Vector Neural Network Instruction set or VNNI) is designed to deliver significant, more efficient Deep Learning (Inference) acceleration for high-performance Artificial Intelligence (AI) workloads.
- Intel Advanced Vector Extensions 512 (AVX-512) enable acceleration of enterprise-class workloads, such as databases and enterprise resource planning.
- Each processor has 6 memory channels with up to two DIMMs per channel. Up to 3 TB of memory capacity using 128GB 3DS RDIMMs. Higher memory capacity by using Persistent Memory.
- Supports 2933 MHz and 2666 MHz memory DIMMs
- Supports the new Intel Optane DC Persistent Memory; up to 12 Data Center Persistent Memory Modules (DCPMMs) can be installed in conjunction with regular memory DIMMs. DCPMMs are up to 512 GB each, for a total of up to 6 TB of Persistent Memory.
- Optional support for high-performance PCIe-attached NVMe Flash Storage solid-state drives (SSDs) can significantly improve I/O performance.
- Embedded 4-port 10Gb Intel adapter built into the system board is based on the Intel Ethernet Connection X722 network controller.
- With Intel Integrated I/O Technology, the PCI Express 3.0 controller is integrated into the Intel Xeon processor Scalable family. This integration helps to dramatically reduce I/O latency and increase overall system performance.
- Support for high-bandwidth I/O adapters; up to two in each SN550 server.
- Support for up to 40 Gb Ethernet, 16 Gb Fibre Channel, and FDR InfiniBand.
- High-speed USB 3.0 port for connectivity to external devices.

Availability and serviceability

The SN550 provides the following features to simplify serviceability and increase system up-time:

- The server offers Single Device Data Correction (SDDC, also known as Chipkill), Adaptive Double-Device Data Correction (ADDDC, also known as Redundant Bit Steering or RBS), memory mirroring, and memory rank sparing for redundancy in the event of a non-correctable memory failure.
- Tool-less cover removal provides easy access to upgrades and serviceable parts, such as CPU, memory, and adapter cards.
- The Dual M.2 Boot Adapter supports RAID-1 which enables two installed M.2 drives to be configured as a redundant pair.
- Hot-swap drives support integrated RAID-1 redundancy for data protection and greater system up-time.
- Solid-state drives (SSDs), which offer significantly better reliability than mechanical HDDs for greater uptime.
- The power source independent light path diagnostics functionality provides individual LEDs that lead the technician to failed (or failing) components, which simplifies servicing, speeds up problem resolution, and helps improve system availability.
- The built-in XClarity Controller continuously monitors system parameters, triggers alerts, and performs recovery actions in case of failures to minimize downtime.
- Proactive Platform Alerts (including PFA and SMART alerts): Processors, voltage regulators, memory, internal storage (SAS/SATA HDDs and SSDs, NVMe SSDs, flash storage adapters), RAID controllers, and server ambient and sub-component temperatures. Alerts can be surfaced through the system XClarity Controller to managers such as Lenovo XClarity Administrator, VMware vCenter, and Microsoft System Center. These proactive alerts let you take appropriate actions in advance of possible failure, thereby increasing server uptime and application availability.
- Built-in diagnostics in UEFI with Lenovo XClarity Provisioning Manager that supports the collection of service data to USB key drive or remote CIFS share folder for troubleshooting and reduced service time.
- Auto-restart in the event of a momentary loss of AC power (based on power policy setting in the XClarity Controller service processor).
- Support for the XClarity Administrator Mobile app running on a supported smartphone and connected to the server through the service-enabled USB port, enables additional local systems management functions.
- Three-year customer replaceable unit and on-site limited warranty; next business day 9x5. Optional service upgrades are available.

Manageability and security

The following powerful systems management features simplify the local and remote management of the SN550:

- Support for Lenovo XClarity Administrator, providing auto-discovery, inventory tracking, monitoring, policy-based firmware updates, address pool management, configuration patterns and operating system installation.
- The server includes an XClarity Controller (XCC) management processor to monitor server availability and perform remote management. XCC Enterprise is supported as standard, which enables remote KVM, mounting of remote media files (ISO and IMG image files), boot capture, and power capping.
- UEFI-based Lenovo XClarity Provisioning Manager, accessible from F1 during boot, provides system inventory information, graphical UEFI Setup, platform update function, RAID Setup wizard, operating system installation function, and diagnostic functions
- Integrated Trusted Platform Module (TPM) 2.0 support enables advanced cryptographic functionality, such as digital signatures and remote attestation.
- Supports Secure Boot to ensure only a digitally signed operating system can be used. Supported with HDDs and SSDs as well as M.2 SSD.
- Support for Lenovo XClarity Energy Manager which captures real-time power and temperature data from the server and provides automated controls to lower energy costs.
- Industry-standard Advanced Encryption Standard (AES) NI support for faster, stronger encryption.

- Intel Execute Disable Bit functionality can help prevent certain classes of malicious buffer overflow attacks when combined with a supporting operating system.
- Intel Trusted Execution Technology provides enhanced security through hardware-based resistance to malicious software attacks, which allows an application to run in its own isolated space that is protected from all other software that is running on a system.

Energy efficiency

The SN550 offers the following energy-efficiency features to save energy, reduce operational costs, increase energy availability, and contribute to a green environment:

- The component-sharing design of the Flex System chassis provides ultimate power and cooling savings.
- The Intel Xeon Processor Scalable Family of processors offer significantly better performance than previous generations of processors, while fitting into the same TDP limits.
- Intel Intelligent Power Capability powers individual processor elements on and off as needed, which reduces power draw.
- Solid state drives (SSDs) use as much as 80% less power than traditional spinning 2.5-inch HDDs.
- The SN550 uses hexagonal ventilation holes, which can be grouped more densely than round holes providing more efficient airflow through the system.

Components and connectors

Figure 2 shows the front of the server.

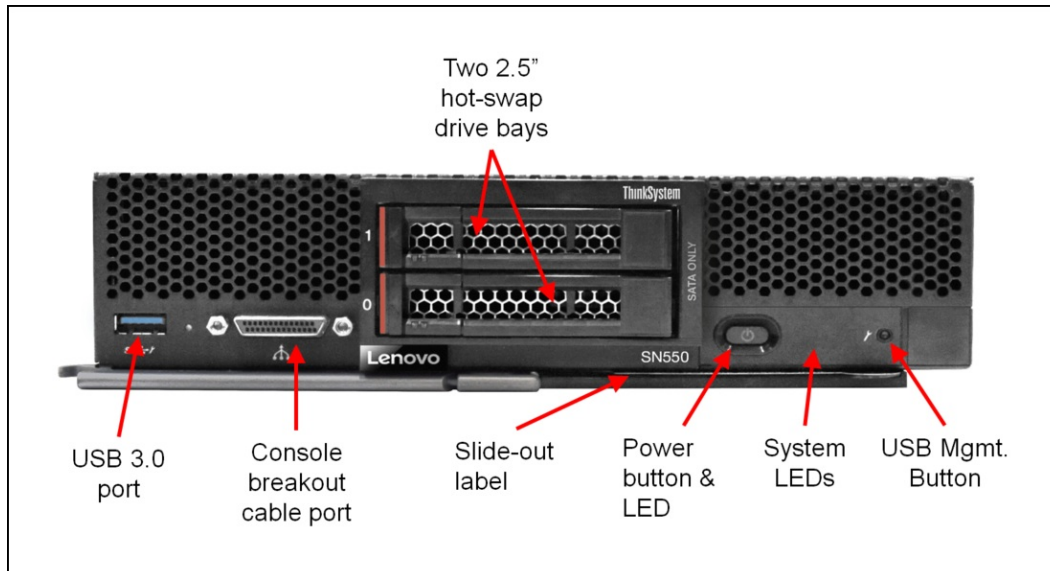

Figure 2. Front view of the ThinkSystem SN550 Compute Node

Figure 3 shows the locations of key components inside the server.

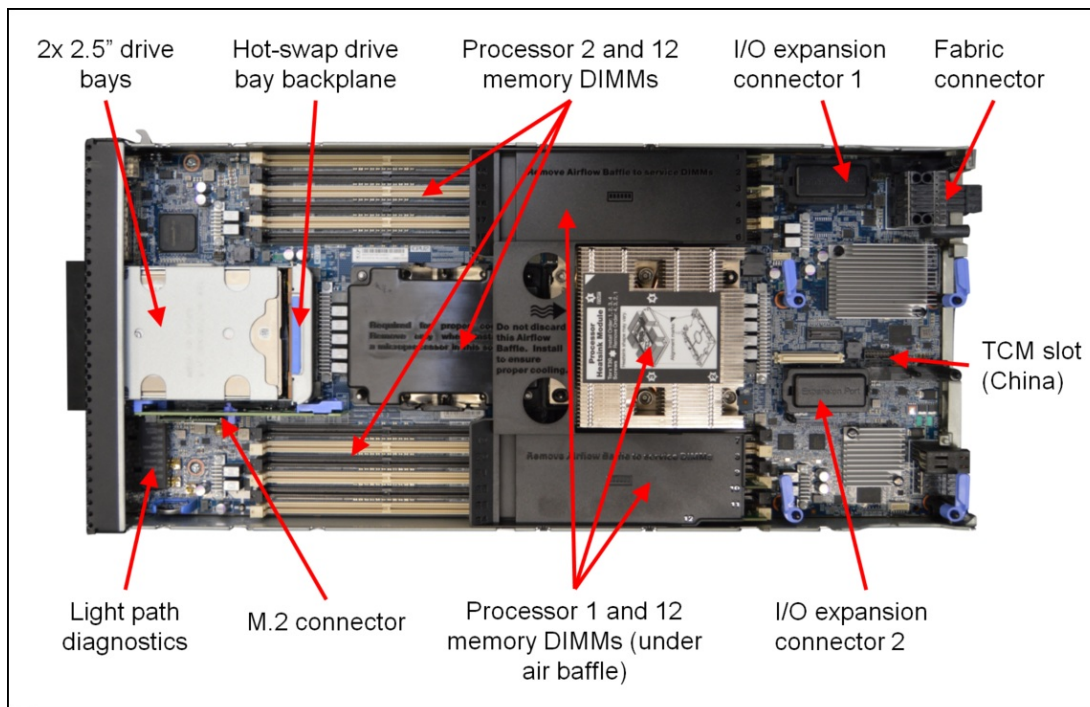

Figure 3. Inside view of the ThinkSystem SN550 server

System architecture

The following figure shows the architectural block diagram of the SN550, showing the major components and their connections.

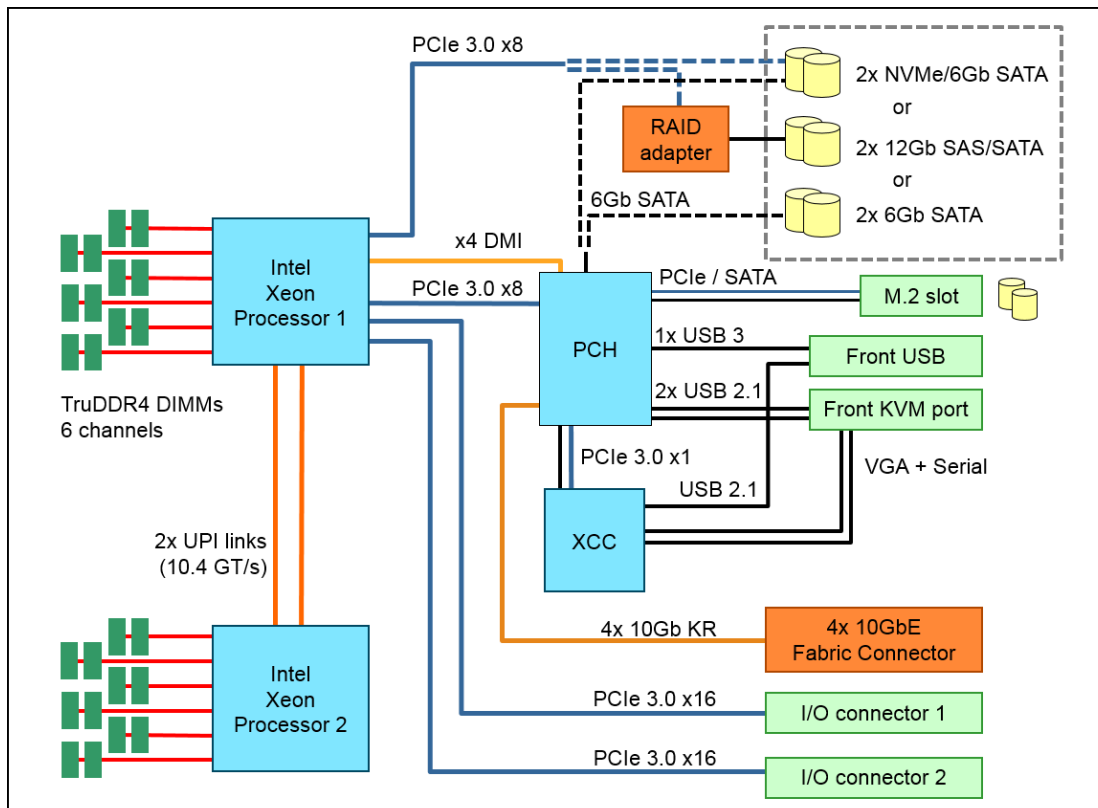

Figure 4. SN550 system architectural block diagram

Standard specifications

The following table lists the standard specifications.

Table 1. Standard specifications

Components	Specification
Machine Type	7X16
Form factor	Standard-width Flex System compute node.
Chassis support	Flex System Enterprise Chassis with CMM2.
Processor	One or two second-generation Intel Xeon Processor Scalable Family of processors (formerly codename "Cascade Lake"). Supports processors with up to 28 cores, core speeds up to 3.8 GHz, and TDP ratings up to 165W.
Chipset	Intel C624
Memory	Up to 24 DIMM sockets (12 DIMMs on 6 channels per processor). DIMM slots are shared between standard system memory and persistent memory. Supports Lenovo TruDDR4 DIMMs at 2933 MHz or 2666 MHz. RDIMMs, LRDIMMs and 3DS RDIMMs are supported (RDIMMs currently only available), but memory types cannot be intermixed.
Persistent memory	Supports up to 12 Intel Optane DC Persistent Memory modules (DCPMMs) installed in the DIMM slots. Persistent memory is installed in combination with system memory DIMMs.

Components	Specification
Memory maximums	<ul style="list-style-type: none"> With system memory DIMMs: Up to 3.0 TB with 24x 128GB 3DS RDIMMs and two processors (1.5 TB per processor) With Persistent Memory in Memory Mode: Up to 6TB of Persistent Memory with 12x 512GB Intel Optane DC Persistent Memory modules and two processors (3TB per processor) With Persistent Memory in App Direct mode (App Direct mode is only supported under Special Bid conditions): Up to 7.5 TB total memory (6TB of Persistent Memory using 12x 512GB DCPMMs + 1.5 TB of system memory using 12x 128GB RDIMMs) with two processors (3.75 TB per processor) <p>Note: Support of more than 1TB per processor requires M-suffix or L-suffix processors with 2TB or 4.5TB memory support respectively. These calculations include any Persistent Memory installed. See the Processor options section for information.</p>
Memory protection	ECC, SDDC (for x4-based memory DIMMs), ADDDC (for x4-based memory DIMMs, requires Intel Xeon Gold or Platinum processors), memory mirroring, and memory sparing.
Disk drives	Two 2.5-inch hot-swap drive bays supporting SSDs or HDDs. Drive bay can be either SATA only, SAS/SATA or NVMe/SATA, depending on the model. Optional support for up to two M.2 SSD.
Maximum internal storage	<ul style="list-style-type: none"> 61.44TB using 2x 30.72TB 2.5-inch SAS/SATA SSDs 15.36TB using 2x 7.68TB 2.5-inch NVMe SSDs 4.8TB using 2x 2.4TB 2.5-inch HDDs No support for the Flex System Storage Expansion Node
RAID support	RAID-0 and RAID-1
Network interfaces	Embedded Intel X722 10 GbE (model specific); optional 1, 10, 25, 40, 50 GbE adapters.
PCI Expansion slots	Two I/O connectors for adapters. PCI Express 3.0 x16 interface. No support for the Flex System PCIe Expansion Node.
Ports	Front: One USB 3.0 port and one console breakout cable port that provides local KVM and serial ports (cable standard with chassis; more cables optional).
Systems management	UEFI, Lenovo XClarity Provisioning Manager, Lenovo XClarity Controller with Pilot4 XE401 baseboard management controller (BMC), Predictive Failure Analysis, light path diagnostics panel, automatic server restart, remote presence. Support for Lenovo XClarity Administrator and Lenovo XClarity Energy Manager.
Security features	Power-on password, administrator's password, Trusted Platform Module (TPM) 1.2 and 2.0, Trusted Cryptographic Module (TCM) - China only.
Video	G200 graphics with 16 MB memory and 2D hardware accelerator, integrated into the XClarity Controller. Maximum resolution is 1920x1200 32bpp at 60Hz.
Limited warranty	Three-year customer-replaceable unit and on-site limited warranty with 9x5/NBD (upgrades available).
Operating systems supported	Microsoft Windows Server, Red Hat Enterprise Linux, SUSE Linux Enterprise Server, VMware ESXi. See the Operating system support section for specifics.
Service and support	Optional service upgrades are available through Lenovo Services: 4-hour or 2-hour response time, 6-hour fix time, 1-year or 2-year warranty extension, software support for Lenovo hardware and some third-party applications.
Dimensions	Width: 218 mm (8.5 in), height: 56 mm (2.2 in), depth: 507 mm (20.0 in)
Weight	Maximum configuration: 7.1 kg (15.6 lb).

SN550 servers are shipped with the following items:

- Documentation flyer

Models

models can be configured by using the [Lenovo Data Center Solution Configurator \(DCSC\)](#).

Configure-to-order (CTO) models are used to create models with factory-integrated server customizations. For CTO models, two base CTO models are available for the SN550 as listed in the following table, CTO1WW and CTOLWW:

- The CTO1WW base CTO model is for general business and is selectable by choosing **General Purpose** mode in DCSC.
- The CTOLWW base model is intended for High Performance Computing (HPC) and Artificial Intelligence (AI) configurations and solutions, including configurations for Lenovo Scalable Infrastructure (LeSI), and is enabled using either the **HPC & AI LeSI Solutions** mode or **HPC & AI Hardware** mode in DCSC. CTOLWW configurations can also be built using [System x and Cluster Solutions Configurator \(x-config\)](#).

Preconfigured server models may also be available for the SN550, however these are region-specific; that is, each region may define their own server models, and not all server models are available in every region.

The following table lists the base CTO models of the server.

Table 2. Base CTO models

Machine Type/Model General purpose	Machine Type/Model for HPC and AI	Description
7X16CTO1WW	7X16CTOLWW	– 3-year Warranty

The following table lists the base chassis choices for CTO configurations with second-generation Intel Xeon Scalable processors.

Table 3. Base chassis for CTO models

Feature code	Description
B4KB	Lenovo ThinkSystem SN550 CLX Server

The following tables list the available models, grouped by region.

- [Models for Australia and New Zealand](#)
- [Models for South East Asian regions \(ASEAN\)](#)
- [Models for EMEA regions](#)
- [Models for Hong Kong, Taiwan, Korea \(HTK\)](#)
- [Models for Japan](#)
- [Models for USA and Canada](#)

Refer to the Specifications section for information about standard features of the server.

Models for Australia and New Zealand

Table 4. Models for Australia and New Zealand

Model	Intel Xeon processors†	Memory	Drive bays	RAID	Drives	M.2 drives	Ethernet*	I/O slots
Standard models								
7X16A05XAU	1x Silver 4208 8C 85W 2.1GHz	1x 32GB 2933	Open	Open	Open	M.2 Single Adapter, Open M.2 drive	Open	0 used, 2 max
7X16A06MAU	1x Silver 4208 8C 85W 2.1GHz	1x 32GB 2933	Open	Open	Open	M.2 Single Adapter, Open M.2 drive	2x 50 GbE adapter	1 used, 2 max
7X16A05YAU	1x Silver 4210 10C 85W 2.2GHz	1x 32GB 2933	Open	Open	Open	M.2 Single Adapter, Open M.2 drive	Open	0 used, 2 max
7X16A06TAU	1x Silver 4214 12C 85W 2.2GHz	1x 32GB 2933	Open	Open	Open	M.2 Single Adapter, Open M.2 drive	Open	0 used, 2 max
7X16A06NAU	1x Silver 4216 16C 100W 2.1GHz	1x 32GB 2933	Open	Open	Open	M.2 Single Adapter, Open M.2 drive	Open	0 used, 2 max
7X16A063AU	1x Gold 5217 8C 115W 3.0GHz	1x 32GB 2933	Open	Open	Open	M.2 Single Adapter, Open M.2 drive	Open	0 used, 2 max
7X16A067AU	1x Gold 5218 16C 125W 2.3GHz	1x 32GB 2933	Open	Open	Open	M.2 Single Adapter, Open M.2 drive	Open	0 used, 2 max
7X16A06UAU	1x Gold 5220 18C 125W 2.2GHz	1x 32GB 2933	Open	Open	Open	M.2 Single Adapter, Open M.2 drive	Open	0 used, 2 max
7X16A065AU	1x Gold 6230 20C 125W 2.1GHz	1x 32GB 2933	Open	Open	Open	M.2 Single Adapter, Open M.2 drive	Open	0 used, 2 max
7X16A06SAU	1x Gold 6240 18C 150W 2.6GHz	1x 32GB 2933	Open	Open	Open	M.2 Single Adapter, Open M.2 drive	Open	0 used, 2 max
7X16A05ZAU	1x Gold 6242 16C 150W 2.8GHz	1x 32GB 2933	Open	Open	Open	M.2 Single Adapter, Open M.2 drive	Open	0 used, 2 max
7X16A06ZAU	1x Gold 6248 20C 150W 2.5GHz	1x 32GB 2933	Open	Open	Open	M.2 Single Adapter, Open M.2 drive	Open	0 used, 2 max
7X16A060AU	1x Gold 6252 24C 150W 2.1GHz	1x 32GB 2933	Open	Open	Open	M.2 Single Adapter, Open M.2 drive	Open	0 used, 2 max

† Processor detail: Quantity, model, core count, TDP, core frequency

* Models with 4x10GbE include a Fabric Connector which routes the embedded X722 10Gb Ethernet controller to I/O slot 1. Models without networking ("Open") can add a Fabric Connector using part number 7M27A03927. The Fabric Connector precludes the use of an I/O adapter in slot 1.

Models for South East Asian regions (ASEAN)

Table 5. Models for South East Asian regions (ASEAN)

Model	Intel Xeon processors†	Memory	Drive bays	RAID	Drives	M.2 drives	Ethernet*	I/O slots
Standard models								
7X16A05XSG	1x Silver 4208 8C 85W 2.1GHz	1x 32GB 2933	Open	Open	Open	M.2 Single Adapter, Open M.2 drive	Open	0 used, 2 max
7X16A06BSG	1x Silver 4208 8C 85W 2.1GHz	1x 32GB 2933	Open	Open	Open	M.2 Single Adapter, Open M.2 drive	2x 50 GbE adapter	1 used, 2 max
7X16A05YSG	1x Silver 4210 10C 85W 2.2GHz	1x 32GB 2933	Open	Open	Open	M.2 Single Adapter, Open M.2 drive	Open	0 used, 2 max
7X16A06TSG	1x Silver 4214 12C 85W 2.2GHz	1x 32GB 2933	Open	Open	Open	M.2 Single Adapter, Open M.2 drive	Open	0 used, 2 max
7X16A073SG	1x Silver 4216 16C 100W 2.1GHz	1x 32GB 2933	Open	Open	Open	M.2 Single Adapter, Open M.2 drive	Open	0 used, 2 max
7X16A076SG	1x Gold 5217 8C 115W 3.0GHz	1x 32GB 2933	Open	Open	Open	M.2 Single Adapter, Open M.2 drive	Open	0 used, 2 max
7X16A077SG	1x Gold 5218 16C 125W 2.3GHz	1x 32GB 2933	Open	Open	Open	M.2 Single Adapter, Open M.2 drive	Open	0 used, 2 max
7X16A06CSG	1x Gold 5220 18C 125W 2.2GHz	1x 32GB 2933	Open	Open	Open	M.2 Single Adapter, Open M.2 drive	Open	0 used, 2 max
7X16A06LSG	1x Gold 6230 20C 125W 2.1GHz	1x 32GB 2933	Open	Open	Open	M.2 Single Adapter, Open M.2 drive	Open	0 used, 2 max
7X16A06ASG	1x Gold 6240 18C 150W 2.6GHz	1x 32GB 2933	Open	Open	Open	M.2 Single Adapter, Open M.2 drive	Open	0 used, 2 max
7X16A05ZSG	1x Gold 6242 16C 150W 2.8GHz	1x 32GB 2933	Open	Open	Open	M.2 Single Adapter, Open M.2 drive	Open	0 used, 2 max
7X16A06ESG	1x Gold 6248 20C 150W 2.5GHz	1x 32GB 2933	Open	Open	Open	M.2 Single Adapter, Open M.2 drive	Open	0 used, 2 max
7X16A061SG	1x Gold 6252 24C 150W 2.1GHz	1x 32GB 2933	Open	Open	Open	M.2 Single Adapter, Open M.2 drive	Open	0 used, 2 max

† Processor detail: Quantity, model, core count, TDP, core frequency

* Models with 4x10GbE include a Fabric Connector which routes the embedded X722 10Gb Ethernet controller to I/O slot 1. Models without networking ("Open") can add a Fabric Connector using part number 7M27A03927. The Fabric Connector precludes the use of an I/O adapter in slot 1.

Models for EMEA regions

Table 6. Models for EMEA regions

Model	Intel Xeon processors†	Memory	Drive bays	RAID	Drives	M.2 drives	Ethernet*	I/O slots
Standard models								
7X16A06DEA	1x Silver 4208 8C 85W 2.1GHz	1x 32GB 2933	Open	Open	Open	M.2 Single Adapter, Open M.2 drive	2x 50 GbE adapter	1 used, 2 max
7X16A06JEA	1x Silver 4208 8C 85W 2.1GHz	1x 32GB 2933	Open	Open	Open	M.2 Single Adapter, Open M.2 drive	Open	0 used, 2 max
7X16A06GEA	1x Silver 4210 10C 85W 2.2GHz	1x 32GB 2933	Open	Open	Open	M.2 Single Adapter, Open M.2 drive	Open	0 used, 2 max
7X16A0BFEA	1x Silver 4210R 10C 100W 2.4GHz	1x 32GB 2933	Open	Open	Open	M.2 Single Adapter, Open M.2 drive	Open	0 used, 2 max
7X16A06HEA	1x Silver 4214 12C 85W 2.2GHz	1x 32GB 2933	Open	Open	Open	M.2 Single Adapter, Open M.2 drive	Open	0 used, 2 max
7X16A06KEA	1x Silver 4216 16C 100W 2.1GHz	1x 32GB 2933	Open	Open	Open	M.2 Single Adapter, Open M.2 drive	Open	0 used, 2 max
7X16A074EA	1x Gold 5217 8C 115W 3.0GHz	1x 32GB 2933	Open	Open	Open	M.2 Single Adapter, Open M.2 drive	Open	0 used, 2 max
7X16A075EA	1x Gold 5218 16C 125W 2.3GHz	1x 32GB 2933	Open	Open	Open	M.2 Single Adapter, Open M.2 drive	Open	0 used, 2 max
7X16A06XEA	1x Gold 5220 18C 125W 2.2GHz	1x 32GB 2933	Open	Open	Open	M.2 Single Adapter, Open M.2 drive	Open	0 used, 2 max
7X16A0BBEA	1x Gold 5222 4C 105W 3.8GHz	1x 32GB 2933	Open	Open	Open	M.2 Single Adapter, 1x 32GB M.2	4x 10 GbE embedded	1 used, 2 max
7X16A0B9EA	1x Gold 6226 12C 125W 2.7GHz	1x 32GB 2933	Open	Open	Open	M.2 Single Adapter, 1x 32GB M.2	4x 10 GbE embedded	1 used, 2 max
7X16A0BKEA	1x Gold 6226R 16C 150W 2.9GHz	1x 32GB 2933	Open	Open	Open	Open	4x 10 GbE embedded	1 used, 2 max
7X16A071EA	1x Gold 6230 20C 125W 2.1GHz	1x 32GB 2933	Open	Open	Open	M.2 Single Adapter, Open M.2 drive	Open	0 used, 2 max
7X16A0BGEA	1x Gold 6230R 26C 150W 2.1GHz	1x 32GB 2933	Open	Open	Open	M.2 Single Adapter, Open M.2 drive	Open	0 used, 2 max
7X16A0BCEA	1x Gold 6234 8C 130W 3.3GHz	1x 32GB 2933	Open	Open	Open	M.2 Single Adapter, 1x 32GB M.2	4x 10 GbE embedded	1 used, 2 max
7X16A06YEA	1x Gold 6240 18C 150W 2.6GHz	1x 32GB 2933	Open	Open	Open	M.2 Single Adapter, Open M.2 drive	Open	0 used, 2 max
7X16A0BEEA	1x Gold 6240R 24C 165W 2.4GHz	1x 32GB 2933	Open	Open	Open	M.2 Single Adapter, Open M.2 drive	Open	0 used, 2 max
7X16A06WEA	1x Gold 6242 16C 150W 2.8GHz	1x 32GB 2933	Open	Open	Open	M.2 Single Adapter, Open M.2 drive	Open	0 used, 2 max
7X16A0BAEA	1x Gold 6246 12C 165W 3.3GHz	1x 32GB 2933	Open	Open	Open	M.2 Single Adapter, 1x 32GB M.2	4x 10 GbE embedded	1 used, 2 max
7X16A06ZEA	1x Gold 6248 20C 150W 2.5GHz	1x 32GB 2933	Open	Open	Open	M.2 Single Adapter, Open M.2 drive	Open	0 used, 2 max
7X16A070EA	1x Gold 6252 24C 150W 2.1GHz	1x 32GB 2933	Open	Open	Open	M.2 Single Adapter, Open M.2 drive	Open	0 used, 2 max

† Processor detail: Quantity, model, core count, TDP, core frequency

* Models with 4x10GbE include a Fabric Connector which routes the embedded X722 10Gb Ethernet controller to I/O slot 1. Models without networking ("Open") can add a Fabric Connector using part number 7M27A03927. The Fabric Connector precludes the use of an I/O adapter in slot 1.

Models for Hong Kong, Taiwan, Korea (HTK)

Table 7. Models for Hong Kong, Taiwan, Korea (HTK)

Model	Intel Xeon processors†	Memory	Drive bays	RAID	Drives	M.2 drives	Ethernet*	I/O slots
Standard models								
7X16A064CN	1x Silver 4208 8C 85W 2.1GHz	1x 32GB 2933	Open	Open	Open	M.2 Single Adapter, Open M.2 drive	Open	0 used, 2 max
7X16A06MCN	1x Silver 4208 8C 85W 2.1GHz	1x 32GB 2933	Open	Open	Open	M.2 Single Adapter, Open M.2 drive	2x 50 GbE adapter	1 used, 2 max
7X16A06RCN	1x Silver 4210 10C 85W 2.2GHz	1x 32GB 2933	Open	Open	Open	M.2 Single Adapter, Open M.2 drive	Open	0 used, 2 max
7X16A06VCN	1x Silver 4214 12C 85W 2.2GHz	1x 32GB 2933	Open	Open	Open	M.2 Single Adapter, Open M.2 drive	Open	0 used, 2 max
7X16A06NCN	1x Silver 4216 16C 100W 2.1GHz	1x 32GB 2933	Open	Open	Open	M.2 Single Adapter, Open M.2 drive	Open	0 used, 2 max
7X16A063CN	1x Gold 5217 8C 115W 3.0GHz	1x 32GB 2933	Open	Open	Open	M.2 Single Adapter, Open M.2 drive	Open	0 used, 2 max
7X16A067CN	1x Gold 5218 16C 125W 2.3GHz	1x 32GB 2933	Open	Open	Open	M.2 Single Adapter, Open M.2 drive	Open	0 used, 2 max
7X16A06UCN	1x Gold 5220 18C 125W 2.2GHz	1x 32GB 2933	Open	Open	Open	M.2 Single Adapter, Open M.2 drive	Open	0 used, 2 max
7X16A065CN	1x Gold 6230 20C 125W 2.1GHz	1x 32GB 2933	Open	Open	Open	M.2 Single Adapter, Open M.2 drive	Open	0 used, 2 max
7X16A06SCN	1x Gold 6240 18C 150W 2.6GHz	1x 32GB 2933	Open	Open	Open	M.2 Single Adapter, Open M.2 drive	Open	0 used, 2 max
7X16A062CN	1x Gold 6242 16C 150W 2.8GHz	1x 32GB 2933	Open	Open	Open	M.2 Single Adapter, Open M.2 drive	Open	0 used, 2 max
7X16A068CN	1x Gold 6248 20C 150W 2.5GHz	1x 32GB 2933	Open	Open	Open	M.2 Single Adapter, Open M.2 drive	Open	0 used, 2 max
7X16A060CN	1x Gold 6252 24C 150W 2.1GHz	1x 32GB 2933	Open	Open	Open	M.2 Single Adapter, Open M.2 drive	Open	0 used, 2 max

† Processor detail: Quantity, model, core count, TDP, core frequency

* Models with 4x10GbE include a Fabric Connector which routes the embedded X722 10Gb Ethernet controller to I/O slot 1. Models without networking ("Open") can add a Fabric Connector using part number 7M27A03927. The Fabric Connector precludes the use of an I/O adapter in slot 1.

Models for Japan

Table 8. Models for Japan

Model	Intel Xeon processors†	Memory	Drive bays	RAID	Drives	M.2 drives	Ethernet*	I/O slots
Standard models								
7X16A0BJJP	1x Gold 6230R 26C 150W 2.1GHz	1x 16GB 1Rx4 2933	Open	Open	Open	Open	Open	0 used, 2 max

† Processor detail: Quantity, model, core count, TDP, core frequency

* Models with 4x10GbE include a Fabric Connector which routes the embedded X722 10Gb Ethernet controller to I/O slot 1. Models without networking ("Open") can add a Fabric Connector using part number 7M27A03927. The Fabric Connector precludes the use of an I/O adapter in slot 1.

Models for USA and Canada

Table 9. Models for USA and Canada

Model	Intel Xeon processors†	Memory	Drive bays	RAID	Drives	M.2 drives	Ethernet*	I/O slots
Standard models								
7X16A07BNA	1x Silver 4208 8C 85W 2.1GHz	2x 16GB 2Rx8 2933	2x NVMe/SATA	RSTe RAID	Open	Open	Open	0 used, 2 max
7X16A07JNA	1x Silver 4208 8C 85W 2.1GHz	2x 16GB 2Rx8 2933	2x NVMe/SATA	RSTe RAID	Open	Open	4x 10 GbE embedded	1 used, 2 max
7X16A07KNA	1x Silver 4214 12C 85W 2.2GHz	2x 16GB 2Rx8 2933	2x NVMe/SATA	RSTe RAID	Open	Open	4x 10 GbE embedded	1 used, 2 max
7X16A07CNA	1x Silver 4214 12C 85W 2.2GHz	2x 32GB 2933	2x NVMe/SATA	RSTe RAID	Open	Open	Open	0 used, 2 max
7X16A07FNA	1x Silver 4216 16C 100W 2.1GHz	2x 16GB 2Rx8 2933	2x NVMe/SATA	RSTe RAID	Open	Open	Open	0 used, 2 max
7X16A07NNA	1x Silver 4216 16C 100W 2.1GHz	2x 16GB 2Rx8 2933	2x NVMe/SATA	RSTe RAID	Open	Open	4x 10 GbE embedded	1 used, 2 max
7X16A07DNA	1x Gold 5218 16C 125W 2.3GHz	2x 16GB 2Rx8 2933	2x NVMe/SATA	RSTe RAID	Open	Open	Open	0 used, 2 max
7X16A07LNA	1x Gold 5218 16C 125W 2.3GHz	2x 16GB 2Rx8 2933	2x NVMe/SATA	RSTe RAID	Open	Open	4x 10 GbE embedded	1 used, 2 max
7X16A07ENA	1x Gold 5220 18C 125W 2.2GHz	2x 16GB 2Rx8 2933	2x NVMe/SATA	RSTe RAID	Open	Open	Open	0 used, 2 max
7X16A07MNA	1x Gold 5220 18C 125W 2.2GHz	2x 16GB 2Rx8 2933	2x NVMe/SATA	RSTe RAID	Open	Open	4x 10 GbE embedded	1 used, 2 max
7X16A07GNA	1x Gold 6230 20C 125W 2.1GHz	2x 32GB 2933	2x NVMe/SATA	RSTe RAID	Open	Open	Open	0 used, 2 max
7X16A07PNA	1x Gold 6230 20C 125W 2.1GHz	2x 32GB 2933	2x NVMe/SATA	RSTe RAID	Open	Open	4x 10 GbE embedded	1 used, 2 max
7X16A07RNA	1x Gold 6252 24C 150W 2.1GHz	2x 32GB 2933	2x NVMe/SATA	RSTe RAID	Open	Open	2x 50 GbE with FCoE	1 used, 2 max

† Processor detail: Quantity, model, core count, TDP, core frequency

* Models with 4x10GbE include a Fabric Connector which routes the embedded X722 10Gb Ethernet controller to I/O slot 1. Models without networking ("Open") can add a Fabric Connector using part number 7M27A03927. The Fabric Connector precludes the use of an I/O adapter in slot 1.

Chassis support

The SN550 server is supported in the Flex System chassis as listed in the following table.

Table 10. Chassis support

Chassis models	Description	Supports SN550
8721-HC1 based: 8721-A1x, LRx, DCx 8721-K1G, E1Y, E2Y	Lenovo Flex System Enterprise Chassis with CMM (68Y7030) standard	No
8721-HC2 based: 8721-ALx, DLx 8721-E3Y, E4Y	Lenovo Flex System Enterprise Chassis with CMM2 (00FJ669) standard	Yes
7385-DCx	Lenovo Flex System Carrier-Grade Chassis	No

Note: CMM2 firmware should be 1.6.1 or later to support ThinkSystem compute nodes

Up to 14 SN550 servers can be installed in the chassis; however, the actual number that can be installed in a chassis depends on the following factors:

- TDP power rating for the processors that are installed in the SN550
- Number of power supplies that are installed in the chassis
- Capacity of the installed power supplies (2100 W or 2500 W)
- The voltage of in the input power
- Chassis power redundancy policy that is used (N+1 or N+N)
- Whether node throttling is permitted

The following table provides guidelines about what number of SN550 servers can be installed. For more information, use Lenovo Capacity Planner, which is found at the following web page:

<https://datacentersupport.lenovo.com/us/en/products/solutions-and-software/software/lenovo-capacity-planner/solutions/ht504651>

The following color coding was used In the table:

- Green = No restriction on the number of SN550 servers that can be installed
- Yellow = Some bays must be left empty in the chassis

Table 11. Maximum number of SN550 servers that can be installed based on input voltage and power redundancy policy used (2500 W power supply)

SN550 CPU TDP rating	With 208V AC supply (2500 W power output)					With 220V or higher AC supply (2745 W power output)				
	N+1, N=5, 6 power supplies, without throttle	N+1, N=4, 5 power supplies, with throttling	N+1, N=3, 4 power supplies, with throttling	N+N, N=3, 6 power supplies, with throttling	N+N, N=3, 6 power supplies, without throttle	N+1, N=5, 6 power supplies, without throttle	N+1, N=4, 5 power supplies, without throttle	N+1, N=3, 4 power supplies, with throttling	N+N, N=3, 6 power supplies, with throttling	N+N, N=3, 6 power supplies, without throttle
85 W	14	14	14	14	12	14	14	14	14	13
105 W	14	14	14	14	11	14	14	14	14	12
125 W	14	14	14	14	10	14	14	14	14	11
130 W	14	14	14	14	10	14	14	14	14	11
140 W	14	14	13	14	9	14	14	14	14	10
150 W	14	14	13	14	9	14	14	14	14	10
165 W	14	14	12	13	8	14	14	14	14	9

Processors

The SN550 supports the second-generation Intel Xeon Scalable processors that are listed in the following table. The server supports one or two processors.

Topics in this section:

- [Continued support for 1st Gen Intel Xeon Scalable processors](#)
- [Memory capacity of processors](#)
- [Processor features](#)
- [UEFI operating modes](#)

First generation processors: The SN550 also supports first-generation Xeon Scalable processors. For details, see <https://lenovopress.com/lp0637>.

All supported processors have the following characteristics:

- Second-generation Intel Xeon Scalable processors (formerly codenamed "Cascade Lake")
- 14 nm process technology
- Six DDR4 memory channels
- 48 PCIe 3.0 I/O lanes
- 1 MB L2 cache
- 1.375 MB or more L3 cache per core
- Intel Hyper-Threading Technology
- Intel Turbo Boost Technology 2.0
- Intel Advanced Vector Extensions 512 (AVX-512)
- Intel Ultra Path Interconnect (UPI) links at up to 10.4 GT/s

Some processors include a suffix letter in the processor model number:

- L: Large memory tier (supports total memory up to 4.5TB per processor)
- M: Medium memory tier (supports total memory up to 2TB per processor)
- N: NFV optimized
- S: Search optimized
- T: High Tcase
- U: Single socket
- V: VM Density optimized
- Y: Speed Select

Processors with a suffix other than L or M, as well as those without a suffix, support up to 1TB per processor.

B suffix: B is not an official suffix, but instead used by Intel to distinguish between the Xeon Gold 5218 and the Xeon Gold 5218B processors. These two processor models have the same core counts, frequencies, and features, however they are based on different die configurations. You should not install 5218 and 5218B processors in the same server.

Table 12. Processor options for the SN550

Part number	Feature code	Description
4XG7A14448	B4HU	Intel Xeon Bronze 3204 6C 85W 1.9GHz Processor
4XG7A37085	B7N3	Intel Xeon Bronze 3206R 8C 85W 1.9GHz Processor
4XG7A14447	B4HT	Intel Xeon Silver 4208 8C 85W 2.1GHz Processor
4XG7A14446	B4P4	Intel Xeon Silver 4209T 8C 70W 2.2GHz Processor
4XG7A14445	B4HS	Intel Xeon Silver 4210 10C 85W 2.2GHz Processor
4XG7A37083	B7N5	Intel Xeon Silver 4210R 10C 100W 2.4GHz Processor
4XG7A14443	B4HR	Intel Xeon Silver 4214 12C 85W 2.2GHz Processor
4XG7A37081	B7N6	Intel Xeon Silver 4214R 12C 100W 2.4GHz Processor
4XG7A14444	B4NW	Intel Xeon Silver 4214Y 12/10/8C 85W 2.2GHz Processor

Part number	Feature code	Description
4XG7A14442	B4HQ	Intel Xeon Silver 4215 8C 85W 2.5GHz Processor
4XG7A37080	BAZU	Intel Xeon Silver 4215R 8C 130W 3.2GHz Processor
4XG7A14441	B4HP	Intel Xeon Silver 4216 16C 100W 2.1GHz Processor
4XG7A14438	B4HN	Intel Xeon Gold 5215 10C 85W 2.5GHz Processor
4XG7A14439	B4P9	Intel Xeon Gold 5215L 10C 85W 2.5GHz Processor
4XG7A14435	B4HM	Intel Xeon Gold 5217 8C 115W 3.0GHz Processor
4XG7A14433	B4HL	Intel Xeon Gold 5218 16C 125W 2.3GHz Processor
4XG7A37150	B6BS	Intel Xeon Gold 5218B 16C 125W 2.3GHz Processor
4XG7A37079	BAZS	Intel Xeon Gold 5218R 20C 125W 2.1GHz Processor
4XG7A14434	B4P3	Intel Xeon Gold 5218T 16C 105W 2.1GHz Processor
4XG7A14432	B4HK	Intel Xeon Gold 5220 18C 125W 2.2GHz Processor
4XG7A37078	B7N9	Intel Xeon Gold 5220R 24C 150W 2.2GHz Processor
4XG7A37114	B6CW	Intel Xeon Gold 5220S 18C 125W 2.7GHz Processor
4XG7A37107	B6CQ	Intel Xeon Gold 5220T 18C 105W 1.9GHz Processor
4XG7A16696	B5S1	Intel Xeon Gold 5222 4C 105W 3.8GHz Processor
4XG7A37118	B6CV	Intel Xeon Gold 6222V 20C 115W 1.8GHz Processor
4XG7A37115	B6CL	Intel Xeon Gold 6226 12C 125W 2.7GHz Processor
4XG7A37076	BAZW	Intel Xeon Gold 6226R 16C 150W 2.9GHz Processor
4XG7A14431	B4HJ	Intel Xeon Gold 6230 20C 125W 2.1GHz Processor
4XG7A16695	B5RY	Intel Xeon Gold 6230N 20C 125W 2.3GHz Processor
4XG7A37075	BAZX	Intel Xeon Gold 6230R 26C 150W 2.1GHz Processor
4XG7A37106	B6CP	Intel Xeon Gold 6230T 20C 125W 2.1GHz Processor
4XG7A37113	B6CK	Intel Xeon Gold 6234 8C 130W 3.3GHz Processor
4XG7A37108	B6CJ	Intel Xeon Gold 6238 22C 140W 2.1GHz Processor
4XG7A37117	B6CR	Intel Xeon Gold 6238L 22C 140W 2.1GHz Processor
4XG7A37074	BAZL	Intel Xeon Gold 6238R 28C 165W 2.2GHz Processor
4XG7A14430	B4P2	Intel Xeon Gold 6238T 22C 125W 1.9GHz Processor
4XG7A14428	B4HH	Intel Xeon Gold 6240 18C 150W 2.6GHz Processor
4XG7A37112	B6CS	Intel Xeon Gold 6240L 18C 150W 2.6GHz Processor
4XG7A37073	BAZM	Intel Xeon Gold 6240R 24C 165W 2.4GHz Processor
4XG7A14427	B4HG	Intel Xeon Gold 6242 16C 150W 2.8GHz Processor
4XG7A14426	B4HF	Intel Xeon Gold 6244 8C 150W 3.6GHz Processor
4XG7A38358	B6PD	Intel Xeon Gold 6246 12C 165W 3.3GHz Processor
4XG7A14425	B4HE	Intel Xeon Gold 6248 20C 150W 2.5GHz Processor
4XG7A14424	B4HC	Intel Xeon Gold 6252 24C 150W 2.1GHz Processor
4XG7A37110	B6CT	Intel Xeon Gold 6252N 24C 150W 2.3GHz Processor
4XG7A37111	B6CU	Intel Xeon Gold 6262V 24C 135W 1.9GHz Processor
4XG7A16694	B5RZ	Intel Xeon Platinum 8253 16C 125W 2.2GHz Processor
4XG7A16693	B5S2	Intel Xeon Platinum 8256 4C 105W 3.8GHz Processor
4XG7A14423	B4HB	Intel Xeon Platinum 8260 24C 165W 2.4GHz Processor
4XG7A14421	B4P7	Intel Xeon Platinum 8260L 24C 165W 2.4GHz Processor
4XG7A14420	B4NU	Intel Xeon Platinum 8260Y 24/20/16C 165W 2.4GHz Processor

Part number	Feature code	Description
4XG7A14417	B4H8	Intel Xeon Platinum 8276 28C 165W 2.2GHz Processor
4XG7A14418	B4P6	Intel Xeon Platinum 8276L 28C 165W 2.2GHz Processor

Continued support for 1st Gen Intel Xeon Scalable processors

The SN550 also continues to support the 1st Gen Intel Xeon Scalable processors (formerly codenamed "Skylake") listed in the following table.

Table 13. Long-life 1st Gen Intel Xeon Scalable processors

Part number	Feature code	Description
-------------	--------------	-------------

* Only available as a field upgrade for existing customers. Not available in CTO (configure to order) configurations.

For specifications of these processors, see the Intel Xeon Scalable Processor Reference for Lenovo ThinkSystem Servers:

<https://lenovopress.com/lp1262-intel-xeon-sp-processor-reference#term=SKL>

Memory capacity of processors

Second-generation Xeon Scalable processors are limited to the amount of memory they can address, as follows:

- Processors with an L suffix (eg 8280L): Up to 4.5 TB per processor
- Processors with an M suffix (eg 8280M): Up to 2 TB per processor (now withdrawn)
- All other processors: Up to 1 TB per processor

The calculation of the total memory per processor includes both the system memory DIMMs and the Persistent Memory DCPMMs installed in the server.

For example:

- A configuration using 12x 64GB DIMMs per processor is a total of 768 GB, which means that neither an M nor an L processor is required
- A configuration using 6x 32GB DIMMs + 6x 256GB DCPMMs is a total of 1.69 TB which means an M processor is required (an L processor may also be used)
- A configuration using 6x 64GB DIMMs + 6x 512GB DCPMMs is a total of 3.375 TB which means an L processor is required

Processor features

The following table compares the features of the supported second-generation Intel Xeon processors.

Abbreviations used in the table:

- UPI: Ultra Path Interconnect
- TDP: Thermal Design Power
- FMA: Number of Intel AVX-512 Fused-Multiply Add (FMA) units
- HT: Hyper-Threading
- TB: Turbo Boost 2.0
- VT: Virtualization Technology (includes VT-x and VT-d)
- SST-PP: Speed Select Technology - Performance Profile
- DCPMM: DC Persistent Memory Module support
- RAS: Reliability, Availability, and Serviceability: Std = Standard, Adv = Advanced

The processors that support SST-PP offer three distinct operating points that are defined by a core count with a base speed associated with that core count. The operating point is selected during the boot process and cannot be changed at runtime.

Table 14. Processor specifications

CPU model	Cores / threads	Core speed (Base / TB max)	L3 cache*	Max memory speed	Max memory per CPU	UPI links & speed	FMA units	TDP	HT	TB	VT	SST-PP	DCPMM	RAS
Intel Xeon 3200 (Bronze) processors														
3204	6 / 6	1.9 / None	8.25 MB	2133 MHz	1 TB	2, 9.6 GT/s	1	85 W	N	N	Y	N	N	Std
3206R	8 / 8	1.9 GHz / None	11 MB	2133 MHz	1 TB	2, 9.6 GT/s	1	85 W	N	N	Y	N	N	Std
Intel Xeon 4200 (Silver) processors														
4208	8 / 16	2.1 / 3.2 GHz	11 MB	2400 MHz	1 TB	2, 9.6 GT/s	1	85 W	Y	Y	Y	N	N	Std
4209T	8 / 16	2.2 / 3.2 GHz	11 MB	2400 MHz	1 TB	2, 9.6 GT/s	1	70 W	Y	Y	Y	N	N	Std
4210	10 / 20	2.2 / 3.2 GHz	13.75 MB	2400 MHz	1 TB	2, 9.6 GT/s	1	85 W	Y	Y	Y	N	N	Std
4210R	10 / 20	2.4 / 3.2 GHz	13.75 MB	2400 MHz	1 TB	2, 9.6 GT/s	1	100 W	Y	Y	Y	N	N	Std
4214	12 / 24	2.2 / 3.2 GHz	16.5 MB	2400 MHz	1 TB	2, 9.6 GT/s	1	85 W	Y	Y	Y	N	N	Std
4214R	12 / 24	2.4 / 3.5 GHz	16.5 MB	2400 MHz	1 TB	2, 9.6 GT/s	1	100 W	Y	Y	Y	N	N	Std
4214Y	12 / 24	2.2 / 3.2 GHz	16.5 MB	2400 MHz	1 TB	2, 9.6 GT/s	1	85 W	Y	Y	Y	Y	N	Std
	10 / 20	2.3 / 3.2 GHz												
	8 / 16	2.4 / 3.2 GHz												
4215	8 / 16	2.5 / 3.5 GHz	11 MB	2400 MHz	1 TB	2, 9.6 GT/s	1	85 W	Y	Y	Y	N	Y	Std
4215R	8 / 16	3.2 / 4.0 GHz	11 MB	2400 MHz	1 TB	2, 9.6 GT/s	1	130 W	Y	Y	Y	N	Y	Std
4216	16 / 32	2.1 / 3.2 GHz	22 MB	2400 MHz	1 TB	2, 9.6 GT/s	1	100 W	Y	Y	Y	N	N	Std
Intel Xeon 5200 (Gold) processors														
5215	10 / 20	2.5 / 3.4 GHz	13.75 MB	2666 MHz	1 TB	2, 10.4 GT/s	1	85 W	Y	Y	Y	N	Y	Adv
5215L	10 / 20	2.5 / 3.4 GHz	13.75 MB	2666 MHz	4.5 TB	2, 10.4 GT/s	1	85 W	Y	Y	Y	N	Y	Adv
5217	8 / 16	3.0 / 3.7 GHz	11 MB	2666 MHz	1 TB	2, 10.4 GT/s	1	115 W	Y	Y	Y	N	Y	Adv
5218**	16 / 32	2.3 / 3.9 GHz	22 MB	2666 MHz	1 TB	2, 10.4 GT/s	1	125 W	Y	Y	Y	N	Y	Adv
5218B**	16 / 32	2.3 / 3.9 GHz	22 MB	2666 MHz	1 TB	2, 10.4 GT/s	1	125 W	Y	Y	Y	N	Y	Adv
5218R	20 / 40	2.1 / 4.0 GHz	27.5 MB	2666 MHz	1 TB	2, 10.4 GT/s	1	125 W	Y	Y	Y	N	Y	Adv
5218T	16 / 32	2.1 / 3.9 GHz	22 MB	2666 MHz	1 TB	2, 10.4 GT/s	1	105 W	Y	Y	Y	N	Y	Adv
5220	18 / 36	2.2 / 3.9 GHz	24.75 MB	2666 MHz	1 TB	2, 10.4 GT/s	1	125 W	Y	Y	Y	N	Y	Adv
5220R	24 / 48	2.2 / 4.0 GHz	35.75 MB*	2666 MHz	1 TB	2, 10.4 GT/s	1	150 W	Y	Y	Y	N	Y	Adv
5220S	18 / 36	2.7 / 3.9 GHz	24.75 MB	2666 MHz	1 TB	2, 10.4 GT/s	1	125 W	Y	Y	Y	N	Y	Adv
5220T	18 / 36	1.9 / 3.9 GHz	24.75 MB	2666 MHz	1 TB	2, 10.4 GT/s	1	105 W	Y	Y	Y	N	Y	Adv
5222	4 / 8	3.8 / 3.9 GHz	16.5 MB*	2933 MHz	1 TB	2, 10.4 GT/s	2	105 W	Y	Y	Y	N	Y	Adv
Intel Xeon 6200 (Gold) processors														
6222V	20 / 40	1.8 / 3.6 GHz	27.5 MB	2400 MHz	1 TB	3, 10.4 GT/s	2	115 W	Y	Y	Y	N	Y	Adv
6226	12 / 24	2.7 / 3.7 GHz	19.25 MB*	2933 MHz	1 TB	3, 10.4 GT/s	2	125 W	Y	Y	Y	N	Y	Adv
6226R	16 / 32	2.9 / 3.9 GHz	22 MB	2933 MHz	1 TB	2, 10.4 GT/s	2	150 W	Y	Y	Y	N	Y	Adv
6230	20 / 40	2.1 / 3.9 GHz	27.5 MB	2933 MHz	1 TB	3, 10.4 GT/s	2	125 W	Y	Y	Y	N	Y	Adv
6230N	20 / 40	2.3 / 3.9 GHz	27.5 MB	2933 MHz	1 TB	3, 10.4 GT/s	2	125 W	Y	Y	Y	N	Y	Adv
6230R	26 / 52	2.1 / 4.0 GHz	35.75 MB	2933 MHz	1 TB	2, 10.4 GT/s	2	150 W	Y	Y	Y	N	Y	Adv
6230T	20 / 40	2.1 / 3.9 GHz	27.5 MB	2933 MHz	1 TB	3, 10.4 GT/s	2	125 W	Y	Y	Y	N	Y	Adv
6234	8 / 16	3.3 / 4.0 GHz	24.75 MB	2933 MHz	1 TB	3, 10.4 GT/s	2	130 W	Y	Y	Y	N	Y	Adv
6238	22 / 44	2.1 / 3.7 GHz	30.25 MB	2933 MHz	1 TB	3, 10.4 GT/s	2	140 W	Y	Y	Y	N	Y	Adv
6238L	22 / 44	2.1 / 3.7 GHz	30.25 MB	2933 MHz	4.5 TB	3, 10.4 GT/s	2	140 W	Y	Y	Y	N	Y	Adv
6238R	28 / 56	2.2 / 4.0 GHz	38.5 MB	2933 MHz	1 TB	2, 10.4 GT/s	2	165 W	Y	Y	Y	N	Y	Adv
6238T	22 / 44	1.9 / 3.7 GHz	30.25 MB	2933 MHz	1 TB	3, 10.4 GT/s	2	125 W	Y	Y	Y	N	Y	Adv
6240	18 / 36	2.6 / 3.9 GHz	24.75 MB	2933 MHz	1 TB	3, 10.4 GT/s	2	150 W	Y	Y	Y	N	Y	Adv
6240L	18 / 36	2.6 / 3.9 GHz	24.75 MB	2933 MHz	4.5 TB	3, 10.4 GT/s	2	150 W	Y	Y	Y	N	Y	Adv
6240R	24 / 48	2.4 / 4.0 GHz	35.75 MB*	2933 MHz	1 TB	2, 10.4 GT/s	2	165 W	Y	Y	Y	N	Y	Adv

CPU model	Cores / threads	Core speed (Base / TB max)	L3 cache*	Max memory speed	Max memory per CPU	UPI links & speed	FMA units	TDP	HT	TB	VT	SST-PP	DCPMM	RAS
6242	16 / 32	2.8 / 3.9 GHz	22 MB	2933 MHz	1 TB	3, 10.4 GT/s	2	150 W	Y	Y	Y	N	Y	Adv
6244	8 / 16	3.6 / 4.4 GHz	24.75 MB*	2933 MHz	1 TB	3, 10.4 GT/s	2	150 W	Y	Y	Y	N	Y	Adv
6246	12 / 24	3.3 / 3.9 GHz	24.75 MB*	2933 MHz	1 TB	3, 10.4 GT/s	2	165 W	Y	Y	Y	N	Y	Adv
6248	20 / 40	2.5 / 3.9 GHz	27.5 MB	2933 MHz	1 TB	3, 10.4 GT/s	2	150 W	Y	Y	Y	N	Y	Adv
6252	24 / 48	2.1 / 3.7 GHz	35.75 MB*	2933 MHz	1 TB	3, 10.4 GT/s	2	150 W	Y	Y	Y	N	Y	Adv
6252N	24 / 48	2.3 / 3.6 GHz	35.75 MB*	2933 MHz	1 TB	3, 10.4 GT/s	2	150 W	Y	Y	Y	N	Y	Adv
6262V	24 / 48	1.9 / 3.6 GHz	33 MB	2400 MHz	1 TB	3, 10.4 GT/s	2	135 W	Y	Y	Y	N	Y	Adv
Intel Xeon 8200 (Platinum) processors														
8253	16 / 32	2.2 / 3.0 GHz	22 MB	2933 MHz	1 TB	3, 10.4 GT/s	2	125 W	Y	Y	Y	N	Y	Adv
8256	4 / 8	3.8 / 3.9 GHz	16.5 MB*	2933 MHz	1 TB	3, 10.4 GT/s	2	105 W	Y	Y	Y	N	Y	Adv
8260	24 / 48	2.4 / 3.9 GHz	35.75 MB*	2933 MHz	1 TB	3, 10.4 GT/s	2	165 W	Y	Y	Y	N	Y	Adv
8260L	24 / 48	2.4 / 3.9 GHz	35.75 MB*	2933 MHz	4.5 TB	3, 10.4 GT/s	2	165 W	Y	Y	Y	N	Y	Adv
8260Y	24 / 48	2.4 / 3.9 GHz	35.75 MB*	2933 MHz	1 TB	3, 10.4 GT/s	2	165 W	Y	Y	Y	Y	Y	Adv
	20 / 40	2.5 / 3.9 GHz												
	16 / 32	2.7 / 3.9 GHz												
8276	28 / 56	2.2 / 4.0 GHz	38.5 MB	2933 MHz	1 TB	3, 10.4 GT/s	2	165 W	Y	Y	Y	N	Y	Adv
8276L	28 / 56	2.2 / 4.0 GHz	38.5 MB	2933 MHz	4.5 TB	3, 10.4 GT/s	2	165 W	Y	Y	Y	N	Y	Adv

* L3 cache is 1.375 MB per core or larger. Processors with a larger L3 cache per core are marked with an *

** The Intel Xeon Gold 5218 and 5218B processors have similar specifications; however, they use different silicon designs and cannot be mixed in the same system.

UEFI operating modes

The SN550 offers preset operating modes that affect energy consumption and performance. These modes are a collection of predefined low-level UEFI settings that simplify the task of tuning the server to suit your business and workload requirements.

The following table lists the feature codes that allow you to specify the mode you wish to preset in the factory for CTO orders.

Table 15. UEFI operating mode presets in DCSC

Feature code	Description
BFYB	Operating mode selection for: "Maximum Performance Mode"
BFYC	Operating mode selection for: "Minimal Power Mode"
BFYD	Operating mode selection for: "Efficiency Favoring Power Savings Mode"
BFYE	Operating mode selection for: "Efficiency - Favoring Performance Mode"

The preset modes for the SN550 are as follows:

- **Maximum Performance Mode** (feature BFYB): Achieves maximum performance but with higher power consumption and lower energy efficiency.
- **Minimal Power Mode** (feature BFYC): Minimize the absolute power consumption of the system.
- **Efficiency Favoring Power Savings Mode** (feature BFYD): Maximize the performance/watt efficiency with a bias towards power savings. It is expected that will be the favored mode for SPECpower benchmark testing for example.
- **Efficiency Favoring Performance Mode** (feature BFYE): Maximize the performance/watt efficiency with a bias towards performance. It is the favored mode for Energy Star certification for example.

For details about these preset modes, and all other performance and power efficiency UEFI settings offered in the SN550, see the paper "Tuning UEFI Settings for Performance and Energy Efficiency on Intel Xeon Scalable Processor-Based ThinkSystem Servers", available from <https://lenovopress.lenovo.com/lp1477>.

Memory options

The SN550 with second-generation Intel Xeon Scalable processors uses Lenovo TruDDR4 memory operating at up to 2933 MHz. The server supports 12 DIMMs per processor, which corresponds to 24 DIMMs with two processors installed. Each processor has six memory channels with two DIMMs per channel.

The SN550 with second-generation Intel Xeon Scalable processors also supports Intel Optane DC Persistent Memory, as described in the [Persistent Memory](#) section.

With second-generation processors, the server supports these memory DIMMs:

- 2666 MHz DIMMs, that operate at 2666 MHz both at 1 DIMM per channel and 2 DIMMs per channel
- 2933 MHz DIMMs, that operate at 2933 MHz at 1 DIMM per channel, and at 2666 MHz at 2 DIMMs per channel

Note that if the processor selected has a lower memory bus speed (eg 2133 MHz or 2400 MHz), then all DIMMs will operate at lower speed, even if the DIMMs are rated for 2666 MHz or 2933 MHz. See the [Processor features](#) section for details.

The following table lists the memory options that are available for the server.

Lenovo TruDDR4 memory uses the highest quality components that are sourced from Tier 1 DRAM suppliers and only memory that meets the strict requirements of Lenovo is selected. It is compatibility tested and tuned to maximize performance and reliability. From a service and support standpoint, Lenovo TruDDR4 memory automatically assumes the system warranty, and Lenovo provides service and support worldwide.

Table 16. Memory options

Part number	Feature code	Description	Maximum supported
2933 MHz DIMMs			
4ZC7A08707	B4LY	ThinkSystem 16GB TruDDR4 2933 MHz (1Rx4 1.2V) RDIMM	24 (12 per processor)
4ZC7A08708	B4H2	ThinkSystem 16GB TruDDR4 2933MHz (2Rx8 1.2V) RDIMM	24 (12 per processor)
4ZC7A08709	B4H3	ThinkSystem 32GB TruDDR4 2933MHz (2Rx4 1.2V) RDIMM	24 (12 per processor)
4ZC7A08710	B4H4	ThinkSystem 64GB TruDDR4 2933MHz (2Rx4 1.2V) RDIMM	24 (12 per processor)
4ZC7A15113	B587	ThinkSystem 128GB TruDDR4 2933MHz (4Rx4 1.2V) 3DS RDIMM	24 (12 per processor)

The following rules apply when selecting the memory configuration:

- The server supports RDIMMs, LRDIMMs and 3DS RDIMMs. UDIMMs are not supported.
- Mixing RDIMMs, LRDIMMs or 3DS RDIMMs is not supported.
- Mixing x4 and x8 DIMMs is supported.
- Mixing of 2666 MHz and 2933 MHz is supported, however, all installed memory will operate at the lowest speed.

For best performance, consider the following:

- Ensure the memory installed is at least the same speed as the memory bus of the selected processor.
- Populate memory DIMMs in quantities of 6 or 12 per processor, so that all memory channels are used.
- When mixing 16 GB and 32 GB DIMMs in the same configuration, use 16GB 2Rx8 DIMMs instead of 16 GB 1Rx4 DIMMs for better performance.
- Populate memory channels so they all have the same total memory capacity.
- Ensure all memory controllers on a processor socket have the same DIMM configuration.

- All processor sockets on the same physical server should have the same DIMM configuration.

The following memory protection technologies are supported:

- ECC
- SDDC (for x4-based memory DIMMs; look for "x4" in the DIMM description)
- ADDDC (for x4-based memory DIMMs)
- Memory mirroring
- Memory rank sparing

If memory channel mirroring is used, then DIMMs must be installed in pairs or sets of three (minimum of one pair or set of three per processor), and all DIMMs in the pair or set of three must be identical in type and size. 50% of the installed capacity is available to the operating system.

If memory rank sparing is used, then a minimum of two single-rank or dual-rank DIMMs must be installed per populated channel (the DIMMs do not need to be identical). In rank sparing mode, one rank of a DIMM in each populated channel is reserved as spare memory. The largest rank in the channel will be automatically selected as the spare rank. The amount of memory available to the operating system depends on the number, capacity and rank counts of the DIMMs installed.

Persistent Memory

The SN550 server supports Intel Optane DC Persistent Memory, a new class of memory and storage technology explicitly architected for data center usage. Persistent Memory offers significantly lower latency than fetching data from SSDs, even NVMe SSDs, and offers higher capacities than system memory.

Using Lenovo ThinkSystem servers running applications that are tuned for Intel Optane DC Persistent Memory will result in lower data latency compared to solid-state drive technology. When data is stored closer to the processor on nonvolatile media, applications can see significant overall improvement in performance.

The following table lists the ordering information for the DC Persistent Memory modules (DCPMMs).

Table 17. DCPMM part numbers

Part number	Feature code	Description	Maximum supported
4ZC7A15110	B4LV	ThinkSystem 128GB TruDDR4 2666MHz (1.2V) Intel Optane DC Persistent Memory	12 (6 per processor)
4ZC7A15111	B4LW	ThinkSystem 256GB TruDDR4 2666MHz (1.2V) Intel Optane DC Persistent Memory	12 (6 per processor)
4ZC7A15112	B4LX	ThinkSystem 512GB TruDDR4 2666MHz (1.2V) Intel Optane DC Persistent Memory	12 (6 per processor)

The following are the requirements when installing DCPMMs:

- Only second-generation Intel Xeon Scalable Family processors support DCPMMs. First generation Xeon Scalable processors are not supported.
- Only the Platinum level, Gold level, and the Silver 4215 processor models support DCPMMs. All other Silver and all Bronze level processors do not support DCPMMs. See the [Processor features](#) section for details.
- Only Memory Mode is supported for all SN550 configurations. App Direct Mode and Mixed Mode are only supported under Special Bid conditions.
- All installed DCPMMs must be the same size. Mixing DCPMMs of different capacities is not supported
- Maximum 6 DCPMMs per processor (install 1 in each memory channel)
- Minimum 2 TruDDR4 DIMMs per processor (1 per memory controller)
- For Memory Mode, minimum 2 DCPMMs per processor (install 1 per memory controller)
- With Memory Mode, the ratio of memory to DCPMMs must be between 1:16 and 1:4, but the recommended ratio is 1:4 for the best performance. For example, 6x 16GB DIMMs + 2x 256GB DCPMMs is a ratio of 1:5.33.

- For each memory channel with both a DCPMM and a TruDDR4 DIMM installed, the DCPMM is installed in channel slot 1 (closest) and the DIMM is installed in channel slot 0
- To maximize performance, balance all memory channels
- Memory mirroring is not supported in DCPMM Memory Mode.
- Memory sparing is not supported with DCPMMs installed

App Direct Mode and Mixed Mode are only supported under Special Bid conditions. Under Special Bid conditions, the following are the requirements:

- For App Direct Mode, minimum 1 DCPMM installed in the server (any processor)
- When Mixed Mode is used, the ratio of memory to DCPMMs must be between 1:16 and 1:4, but the recommended ratio is 1:4 for the best performance. For example, 6x 16GB DIMMs + 2x 256GB DCPMMs is a ratio of 1:5.33. This ratio requirement does not apply to App Direct mode.
- In configurations with DCPMMs installed, memory mirroring is supported, with two restrictions:
 - Mirroring is only enabled on the DRAM DIMMs installed in the server; The DCPMMs themselves do not support mirroring.
 - Only App Direct mode is supported. Memory mirroring cannot be enabled when DCPMMs are in Memory Mode or Mixed Mode.

DCPMMs offer the following memory protection technologies:

- ECC
- SDDC
- DDDC
- Patrol scrubbing
- Demand scrubbing

For more information, see the Intel Optane DC Persistent Memory (DCPMM) product guide, <https://lenovopress.com/LP1066>

Internal storage

The SN550 server has two 2.5-inch hot-swap drive bays that are accessible from the front of the blade server (see [Figure 2](#)). Depending on server configuration and installed backplane, these bays connect to either the included 6 Gbps SATA controller, optional Lenovo RAID controllers or directly to PCIe lanes for NVMe drives.

In addition, the SN550 can also support one or two M.2 form factor SSD drives on a separate adapter. The following table lists the supported M.2 adapters (enablement kits). For more information, see the ThinkSystem M.2 Drives and M.2 Adapters product guide: <https://lenovopress.com/ip0769>

Virtualization support: The integrated SATA controller can be used with virtualization hypervisors, including VMware ESXi, Linux KVM, Xen, and Microsoft Hyper-V. However, support is limited to AHCI (non-RAID) mode. RSTe mode is not supported with virtualization hypervisors.

Table 18. Internal storage upgrades

Part number	Feature code	Name and description	Maximum supported
7M27A03915	AUYP	ThinkSystem SATA Backplane for SN550	1
7M27A03916	AUYQ	ThinkSystem NVMe/SATA Backplane for SN550	1
7M27A03917	AUYS	ThinkSystem RAID 930-4i-2GB 2 Drive Adapter Kit for SN550	1
7M27A03918	AUYR	ThinkSystem RAID 530-4i 2 Drive Adapter Kit for SN550	1
CTO only*	AUMU	ThinkSystem M.2 Enablement Kit (Single M.2 Adapter)	1
7Y37A01093	AUMV	ThinkSystem M.2 with Mirroring Enablement Kit (Dual M.2 Adapter)	1

* The ThinkSystem M.2 Enablement Kit is available configure-to-order only; not available as a standalone option

Supported drives are listed in the [Internal drive options](#) section.

SED encryption key management with ISKLM

The server supports self-encrypting drives (SEDs) as listed in the [Internal drive options](#) section. To effectively manage a large deployment of these drives in Lenovo servers, IBM Security Key Lifecycle Manager (SKLM) offers a centralized key management solution. A Lenovo Feature on Demand (FoD) upgrade is used to enable this SKLM support in the management processor of the server.

The following table lists the part numbers and feature codes for the upgrades.

Table 19. FoD upgrades for SKLM support

Part number	Feature code	Description
Security Key Lifecycle Manager - FoD (United States, Canada, Asia Pacific, and Japan)		
00D9998	A5U1	SKLM for System x/ThinkSystem w/SEDs - FoD per Install with 1 year S&S
00D9999	AS6C	SKLM for System x/ThinkSystem w/SEDs - FoD per Install with 3 year S&S
Security Key Lifecycle Manager - FoD (Latin America, Europe, Middle East, and Africa)		
00FP648	A5U1	SKLM for System x/ThinkSystem w/SEDs - FoD per Install with 1 year S&S
00FP649	AS6C	SKLM for System x/ThinkSystem w/SEDs - FoD per Install with 3 year S&S

The IBM Security Key Lifecycle Manager software is available from Lenovo using the ordering information listed in the following table.

Table 20. IBM Security Key Lifecycle Manager licenses

Part number	Description
7S0A007FWW	IBM Security Key Lifecycle Manager Basic Edition Install License + SW Subscription & Support 12 Months
7S0A007HWW	IBM Security Key Lifecycle Manager For Raw Decimal Terabyte Storage Resource Value Unit License + SW Subscription & Support 12 Months
7S0A007KWW	IBM Security Key Lifecycle Manager For Raw Decimal Petabyte Storage Resource Value Unit License + SW Subscription & Support 12 Months
7S0A007MWW	IBM Security Key Lifecycle Manager For Usable Decimal Terabyte Storage Resource Value Unit License + SW Subscription & Support 12 Months
7S0A007PWW	IBM Security Key Lifecycle Manager For Usable Decimal Petabyte Storage Resource Value Unit License + SW Subscription & Support 12 Months

Controllers for internal storage

In addition to the optional M.2 RAID-1 enabled adapter, the SN550 supports 3 different RAID controllers as shown in the table below.

Table 21. SN550 RAID controllers with features

Feature	Onboard	RAID 530-4i	RAID 930-4i
Adapter type	Software RAID	RAID controller	RAID controller
Part number	None	7M27A03918	7M27A03917
Form factor	Integrated	Adapter	Adapter
Controller chip	Intel PCH (RSTe)	LSI SAS3404	LSI SAS3504
Host interface	Not applicable	PCIe 3.0x8	PCIe 3.0x8
Port interface	6 Gb SATA	12 Gb SAS	12 Gb SAS
Drive interface	SATA	SAS, SATA	SAS, SATA
Drive type	HDD, SSD	HDD, SED, SSD	HDD, SED, SSD
Hot-swap drives	Yes	Yes	Yes
Max devices	2	2	2
RAID levels	0, 1	0, 1	0, 1
JBOD mode	Yes	Yes	Yes
Cache	No	No	2GB (Standard)
CacheVault cache protection	No	No	Yes (Flash)
Performance Accelerator (FastPath)	No	Yes	Yes
SED support	No	Yes	Yes

Both the 530-4i and 930-4i replace the onboard SATA controller in the server and support high-performance RAID-0 and RAID-1 to the two internal 2.5-inch drive bays. These controllers are installed at the front of the server over the top of the drive bays.

The following figure shows the ThinkSystem RAID 530-4i adapter for the SN550 blade server. Note that the plastic frame in the lower right of the adapter is part of the mechanism that attaches the adapter to the server; this adapter does not support a supercapacitor.

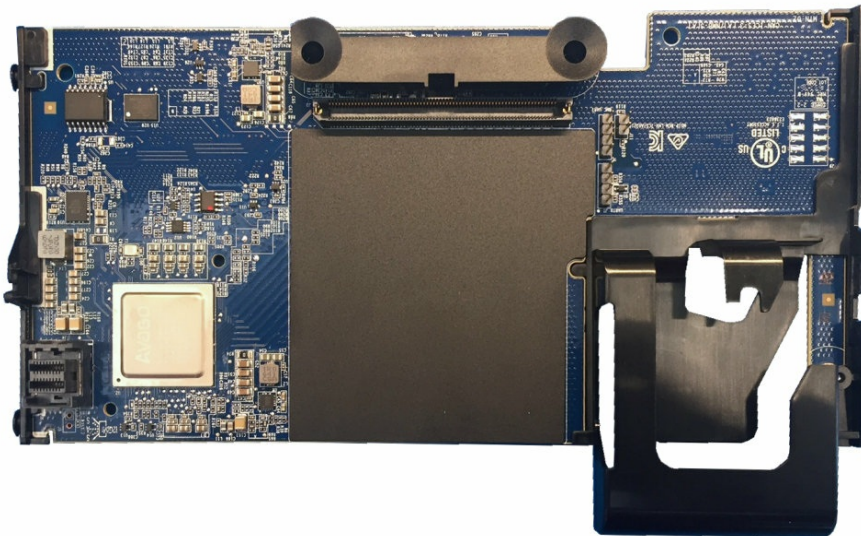

Figure 5. ThinkSystem RAID 530-4i 2 Drive Adapter

Both ThinkSystem RAID Adapters for SN550 include the following components:

- RAID controller
- Replacement 2-drive SAS/SATA backplane

Internal drive options

The following tables list the drive options for internal storage of the server.

2.5-inch hot-swap drives:

- [2.5-inch hot-swap 12 Gb SAS HDDs](#)
- [2.5-inch hot-swap 6 Gb SATA HDDs](#)
- [2.5-inch hot-swap 24 Gb SAS SSDs](#)
- [2.5-inch hot-swap 12 Gb SAS SSDs](#)
- [2.5-inch hot-swap 6 Gb SATA SSDs](#)
- [2.5-inch hot-swap PCIe 4.0 NVMe SSDs](#)
- [2.5-inch hot-swap PCIe 3.0 NVMe SSDs](#)

M.2 drives:

- [M.2 SATA drives](#)

M.2 drive support: The use of M.2 drives requires an additional adapter as described in the [M.2 drives](#) subsection.

SED support: The tables include a column to indicate which drives support SED encryption. The encryption functionality can be disabled if needed. Note: Not all SED-enabled drives have "SED" in the description.

PCIe 4.0 NVMe drive support: When installed in this server, PCIe 4.0 NVMe drives will operate at PCIe 3.0 speeds.

Table 22. 2.5-inch hot-swap 12 Gb SAS HDDs

Part number	Feature code	Description	SED support	Max Qty
2.5-inch hot-swap HDDs - 12 Gb SAS 15K				
7XB7A00021	AULV	ThinkSystem 2.5" 300GB 15K SAS 12Gb Hot Swap 512n HDD	No	2
7XB7A00022	AULW	ThinkSystem 2.5" 600GB 15K SAS 12Gb Hot Swap 512n HDD	No	2
7XB7A00023	AULX	ThinkSystem 2.5" 900GB 15K SAS 12Gb Hot Swap 512e HDD	No	2
2.5-inch hot-swap HDDs - 12 Gb SAS 10K				
7XB7A00024	AULY	ThinkSystem 2.5" 300GB 10K SAS 12Gb Hot Swap 512n HDD	No	2
7XB7A00025	AULZ	ThinkSystem 2.5" 600GB 10K SAS 12Gb Hot Swap 512n HDD	No	2
7XB7A00026	AUM0	ThinkSystem 2.5" 900GB 10K SAS 12Gb Hot Swap 512n HDD	No	2
7XB7A00027	AUM1	ThinkSystem 2.5" 1.2TB 10K SAS 12Gb Hot Swap 512n HDD	No	2
7XB7A00028	AUM2	ThinkSystem 2.5" 1.8TB 10K SAS 12Gb Hot Swap 512e HDD	No	2
7XB7A00069	B0YS	ThinkSystem 2.5" 2.4TB 10K SAS 12Gb Hot Swap 512e HDD	No	2
2.5-inch hot-swap HDDs - 12 Gb NL SAS				
7XB7A00034	AUM6	ThinkSystem 2.5" 1TB 7.2K SAS 12Gb Hot Swap 512n HDD	No	2
7XB7A00035	AUM7	ThinkSystem 2.5" 2TB 7.2K SAS 12Gb Hot Swap 512n HDD	No	2
2.5-inch hot-swap SED HDDs - 12 Gb SAS 10K				
7XB7A00031	AUM5	ThinkSystem 2.5" 600GB 10K SAS 12Gb Hot Swap 512n HDD SED	Support	2
7XB7A00033	B0YX	ThinkSystem 2.5" 1.2TB 10K SAS 12Gb Hot Swap 512n HDD SED	Support	2

Table 23. 2.5-inch hot-swap 6 Gb SATA HDDs

Part number	Feature code	Description	SED support	Max Qty
2.5-inch hot-swap HDDs - 6 Gb NL SATA				
7XB7A00036	AUUE	ThinkSystem 2.5" 1TB 7.2K SATA 6Gb Hot Swap 512n HDD	No	2
7XB7A00037	AUUJ	ThinkSystem 2.5" 2TB 7.2K SATA 6Gb Hot Swap 512e HDD	No	2

Table 24. 2.5-inch hot-swap 24 Gb SAS SSDs

Part number	Feature code	Description	SED support	Max Qty
2.5-inch hot-swap SSDs - 24 Gb SAS - Mixed Use/Mainstream (3-5 DWPD)				
4XB7A80340	BNW8	ThinkSystem 2.5" PM1655 800GB Mixed Use SAS 24Gb HS SSD	Support	2
4XB7A80341	BNW9	ThinkSystem 2.5" PM1655 1.6TB Mixed Use SAS 24Gb HS SSD	Support	2
4XB7A80342	BNW6	ThinkSystem 2.5" PM1655 3.2TB Mixed Use SAS 24Gb HS SSD	Support	2
4XB7A80343	BP3K	ThinkSystem 2.5" PM1655 6.4TB Mixed Use SAS 24Gb HS SSD	Support	2
2.5-inch hot-swap SSDs - 24 Gb SAS - Read Intensive/Entry/Capacity (<3 DWPD)				
4XB7A80318	BNWC	ThinkSystem 2.5" PM1653 960GB Read Intensive SAS 24Gb HS SSD	Support	2
4XB7A80319	BNWE	ThinkSystem 2.5" PM1653 1.92TB Read Intensive SAS 24Gb HS SSD	Support	2
4XB7A80320	BNWF	ThinkSystem 2.5" PM1653 3.84TB Read Intensive SAS 24Gb HS SSD	Support	2
4XB7A80321	BP3E	ThinkSystem 2.5" PM1653 7.68TB Read Intensive SAS 24Gb HS SSD	Support	2
4XB7A80322	BP3J	ThinkSystem 2.5" PM1653 15.36TB Read Intensive SAS 24Gb HS SSD	Support	2
4XB7A80323	BP3D	ThinkSystem 2.5" PM1653 30.72TB Read Intensive SAS 24Gb HS SSD	Support	2

Table 25. 2.5-inch hot-swap 12 Gb SAS SSDs

Part number	Feature code	Description	SED support	Max Qty
2.5-inch hot-swap SSDs - 12 Gb SAS - Write Intensive/Performance (10+ DWPD)				
4XB7A83214	BR10	ThinkSystem 2.5" Nytro 3750 400GB Write Intensive SAS 12Gb HS SSD	Support	2
4XB7A83215	BR0Z	ThinkSystem 2.5" Nytro 3750 800GB Write Intensive SAS 12Gb HS SSD	Support	2
4XB7A83216	BR0Y	ThinkSystem 2.5" Nytro 3750 1.6TB Write Intensive SAS 12Gb HS SSD	Support	2
4XB7A83217	BR0X	ThinkSystem 2.5" Nytro 3750 3.2TB Write Intensive SAS 12Gb HS SSD	Support	2
4XB7A70006	BG07	ThinkSystem 2.5" Nytro 3732 400GB Performance SAS 12Gb Hot Swap SSD	No	2
4XB7A70005	BG06	ThinkSystem 2.5" Nytro 3732 800GB Performance SAS 12Gb Hot Swap SSD	No	2
4XB7A70007	BFZZ	ThinkSystem 2.5" Nytro 3732 800GB Performance SAS 12Gb Hot Swap SSD SED	Support	2
4XB7A70004	BG05	ThinkSystem 2.5" Nytro 3732 1.6TB Performance SAS 12Gb Hot Swap SSD	No	2
4XB7A70003	BG04	ThinkSystem 2.5" Nytro 3732 3.2TB Performance SAS 12Gb Hot Swap SSD	No	2
2.5-inch hot-swap SSDs - 12 Gb SAS - Mixed Use/Mainstream (3-5 DWPD)				
4XB7A17062	B8HU	ThinkSystem 2.5" PM1645a 800GB Mainstream SAS 12Gb Hot Swap SSD	No	2
4XB7A17063	B8J4	ThinkSystem 2.5" PM1645a 1.6TB Mainstream SAS 12Gb Hot Swap SSD	No	2
4XB7A17064	B8JD	ThinkSystem 2.5" PM1645a 3.2TB Mainstream SAS 12Gb Hot Swap SSD	No	2
4XB7A17065	B8JA	ThinkSystem 2.5" PM1645a 6.4TB Mainstream SAS 12Gb Hot Swap SSD	No	2
2.5-inch hot-swap SSDs - 12 Gb SAS - Read Intensive/Entry/Capacity (<3 DWPD)				
4XB7A38175	B91A	ThinkSystem 2.5" PM1643a 960GB Entry SAS 12Gb Hot Swap SSD	No	2
4XB7A38176	B91B	ThinkSystem 2.5" PM1643a 1.92TB Entry SAS 12Gb Hot Swap SSD	No	2
4XB7A17054	B91C	ThinkSystem 2.5" PM1643a 3.84TB Entry SAS 12Gb Hot Swap SSD	No	2
4XB7A17055	B91D	ThinkSystem 2.5" PM1643a 7.68TB Entry SAS 12Gb Hot Swap SSD	No	2
4XB7A17056	BC4R	ThinkSystem 2.5" PM1643a 15.36TB Entry SAS 12Gb Hot Swap SSD	No	2

Table 26. 2.5-inch hot-swap 6 Gb SATA SSDs

Part number	Feature code	Description	SED support	Max Qty
2.5-inch hot-swap SSDs - 6 Gb SATA - Mixed Use/Mainstream (3-5 DWPD)				
4XB7A82289	BQ21	ThinkSystem 2.5" 5400 MAX 480GB Mixed Use SATA 6Gb HS SSD	Support	2
4XB7A82290	BQ24	ThinkSystem 2.5" 5400 MAX 960GB Mixed Use SATA 6Gb HS SSD	Support	2
4XB7A82291	BQ22	ThinkSystem 2.5" 5400 MAX 1.92TB Mixed Use SATA 6Gb HS SSD	Support	2
4XB7A82292	BQ23	ThinkSystem 2.5" 5400 MAX 3.84TB Mixed Use SATA 6Gb HS SSD	Support	2
4XB7A17125	BA7Q	ThinkSystem 2.5" S4620 480GB Mixed Use SATA 6Gb HS SSD	No	2
4XB7A17126	BA4T	ThinkSystem 2.5" S4620 960GB Mixed Use SATA 6Gb HS SSD	No	2
4XB7A17127	BA4U	ThinkSystem 2.5" S4620 1.92TB Mixed Use SATA 6Gb HS SSD	No	2
4XB7A17128	BK7L	ThinkSystem 2.5" S4620 3.84TB Mixed Use SATA 6Gb HS SSD	No	2
4XB7A17087	B8J1	ThinkSystem 2.5" 5300 240GB Mainstream SATA 6Gb Hot Swap SSD	No	2
4XB7A17088	B8HY	ThinkSystem 2.5" 5300 480GB Mainstream SATA 6Gb Hot Swap SSD	No	2
4XB7A17089	B8J6	ThinkSystem 2.5" 5300 960GB Mainstream SATA 6Gb Hot Swap SSD	No	2
4XB7A17090	B8JE	ThinkSystem 2.5" 5300 1.92TB Mainstream SATA 6Gb Hot Swap SSD	No	2
4XB7A17091	B8J7	ThinkSystem 2.5" 5300 3.84TB Mainstream SATA 6Gb Hot Swap SSD	No	2

Part number	Feature code	Description	SED support	Max Qty
4XB7A13633	B49L	ThinkSystem 2.5" S4610 240GB Mixed Use SATA 6Gb HS SSD	No	2
4XB7A13637	B49Q	ThinkSystem 2.5" S4610 3.84TB Mixed Use SATA 6Gb HS SSD	No	2
2.5-inch hot-swap SSDs - 6 Gb SATA - Read Intensive/Entry (<3 DWPD)				
4XB7A82258	BQ1Q	ThinkSystem 2.5" 5400 PRO 240GB Read Intensive SATA 6Gb HS SSD	Support	2
4XB7A82259	BQ1P	ThinkSystem 2.5" 5400 PRO 480GB Read Intensive SATA 6Gb HS SSD	Support	2
4XB7A82260	BQ1R	ThinkSystem 2.5" 5400 PRO 960GB Read Intensive SATA 6Gb HS SSD	Support	2
4XB7A82261	BQ1X	ThinkSystem 2.5" 5400 PRO 1.92TB Read Intensive SATA 6Gb HS SSD	Support	2
4XB7A82262	BQ1S	ThinkSystem 2.5" 5400 PRO 3.84TB Read Intensive SATA 6Gb HS SSD	Support	2
4XB7A82263	BQ1T	ThinkSystem 2.5" 5400 PRO 7.68TB Read Intensive SATA 6Gb HS SSD	Support	2
4XB7A72438	BM8B	ThinkSystem 2.5" PM893 480GB Read Intensive SATA 6Gb HS SSD	No	2
4XB7A72439	BM8A	ThinkSystem 2.5" PM893 960GB Read Intensive SATA 6Gb HS SSD	No	2
4XB7A72440	BM89	ThinkSystem 2.5" PM893 1.92TB Read Intensive SATA 6Gb HS SSD	No	2
4XB7A72441	BM88	ThinkSystem 2.5" PM893 3.84TB Read Intensive SATA 6Gb HS SSD	No	2
4XB7A72442	BM87	ThinkSystem 2.5" PM893 7.68TB Read Intensive SATA 6Gb HS SSD	No	2
4XB7A17072	B99D	ThinkSystem 2.5" S4520 240GB Read Intensive SATA 6Gb HS SSD	No	2
4XB7A17101	BA7G	ThinkSystem 2.5" S4520 480GB Read Intensive SATA 6Gb HS SSD	No	2
4XB7A17102	BA7H	ThinkSystem 2.5" S4520 960GB Read Intensive SATA 6Gb HS SSD	No	2
4XB7A17103	BA7J	ThinkSystem 2.5" S4520 1.92TB Read Intensive SATA 6Gb HS SSD	No	2
4XB7A17104	BK77	ThinkSystem 2.5" S4520 3.84TB Read Intensive SATA 6Gb HS SSD	No	2
4XB7A17105	BK78	ThinkSystem 2.5" S4520 7.68TB Read Intensive SATA 6Gb HS SSD	No	2
4XB7A38271	BCTC	ThinkSystem 2.5" Multi Vendor 240GB Entry SATA 6Gb Hot Swap SSD	No	2
4XB7A38272	BCTD	ThinkSystem 2.5" Multi Vendor 480GB Entry SATA 6Gb Hot Swap SSD	No	2
4XB7A38273	BCTE	ThinkSystem 2.5" Multi Vendor 960GB Entry SATA 6Gb Hot Swap SSD	No	2
4XB7A38274	BCTF	ThinkSystem 2.5" Multi Vendor 1.92TB Entry SATA 6Gb Hot Swap SSD	No	2
4XB7A38275	BCTG	ThinkSystem 2.5" Multi Vendor 3.84TB Entry SATA 6Gb Hot Swap SSD	No	2
4XB7A17075	B8HV	ThinkSystem 2.5" 5300 240GB Entry SATA 6Gb Hot Swap SSD	No	2
4XB7A17076	B8JM	ThinkSystem 2.5" 5300 480GB Entry SATA 6Gb Hot Swap SSD	No	2
4XB7A17077	B8HP	ThinkSystem 2.5" 5300 960GB Entry SATA 6Gb Hot Swap SSD	No	2
4XB7A17078	B8J5	ThinkSystem 2.5" 5300 1.92TB Entry SATA 6Gb Hot Swap SSD	No	2
4XB7A17079	B8JP	ThinkSystem 2.5" 5300 3.84TB Entry SATA 6Gb Hot Swap SSD	No	2
4XB7A17080	B8J2	ThinkSystem 2.5" 5300 7.68TB Entry SATA 6Gb Hot Swap SSD	No	2
4XB7A38185	B9AC	ThinkSystem 2.5" 5210 960GB Entry SATA 6Gb Hot Swap QLC SSD	No	2
4XB7A38144	B7EW	ThinkSystem 2.5" 5210 1.92TB Entry SATA 6Gb Hot Swap QLC SSD	No	2
4XB7A38145	B7EX	ThinkSystem 2.5" 5210 3.84TB Entry SATA 6Gb Hot Swap QLC SSD	No	2
4XB7A38146	B7EY	ThinkSystem 2.5" 5210 7.68TB Entry SATA 6Gb Hot Swap QLC SSD	No	2
4XB7A10197	B34K	ThinkSystem 2.5" PM883 960GB Entry SATA 6Gb Hot Swap SSD	No	2
4XB7A10198	B34L	ThinkSystem 2.5" PM883 1.92TB Entry SATA 6Gb Hot Swap SSD	No	2
4XB7A10200	B4D2	ThinkSystem 2.5" PM883 7.68TB Entry SATA 6Gb Hot Swap SSD	No	2

Table 27. 2.5-inch hot-swap PCIe 4.0 NVMe SSDs

Part number	Feature code	Description	SED support	Max Qty
2.5-inch SSDs - U.2 PCIe 4.0 NVMe - Mixed Use/Mainstream (3-5 DWPD)				
4XB7A17129	BNEG	ThinkSystem 2.5" U.2 P5620 1.6TB Mixed Use NVMe PCIe 4.0 x4 HS SSD	Support	2
4XB7A17130	BNEH	ThinkSystem 2.5" U.2 P5620 3.2TB Mixed Use NVMe PCIe 4.0 x4 HS SSD	Support	2
4XB7A17133	BNEZ	ThinkSystem 2.5" U.2 P5620 6.4TB Mixed Use NVMe PCIe 4.0 x4 HS SSD	Support	2
4XB7A17152	BCFV	ThinkSystem 2.5" U.2 P5600 1.6TB Mixed Use NVMe PCIe 4.0 x4 HS SSD	No	2
2.5-inch SSDs - U.3 PCIe 4.0 NVMe - Mixed Use/Mainstream (3-5 DWPD)				
4XB7A79639	BNF1	ThinkSystem 2.5" U.3 7450 MAX 800GB Mixed Use NVMe PCIe 4.0 x4 HS SSD	Support	2
4XB7A13967	BNEJ	ThinkSystem 2.5" U.3 7450 MAX 1.6TB Mixed Use NVMe PCIe 4.0 x4 HS SSD	Support	2
4XB7A13970	BNEY	ThinkSystem 2.5" U.3 7450 MAX 3.2TB Mixed Use NVMe PCIe 4.0 x4 HS SSD	Support	2
4XB7A13971	BNEL	ThinkSystem 2.5" U.3 7450 MAX 6.4TB Mixed Use NVMe PCIe 4.0 x4 HS SSD	Support	2
4XB7A64175	BE03	ThinkSystem U.3 Kioxia CM6-V 800GB Mainstream NVMe PCIe 4.0 x4 Hot Swap SSD	No	2
4XB7A17112	B96Z	ThinkSystem U.3 Kioxia CM6-V 1.6TB Mainstream NVMe PCIe4.0 x4 Hot Swap SSD	No	2
4XB7A17113	B96T	ThinkSystem U.3 Kioxia CM6-V 3.2TB Mainstream NVMe PCIe4.0 x4 Hot Swap SSD	No	2
4XB7A17114	B96P	ThinkSystem U.3 Kioxia CM6-V 6.4TB Mainstream NVMe PCIe4.0 x4 Hot Swap SSD	No	2
2.5-inch SSDs - U.2 PCIe 4.0 NVMe - Read Intensive/Entry (<3 DWPD)				
4XB7A13941	BMGD	ThinkSystem 2.5" U.2 P5520 1.92TB Read Intensive NVMe PCIe 4.0 x4 HS SSD	Support	2
4XB7A13942	BMGE	ThinkSystem 2.5" U.2 P5520 3.84TB Read Intensive NVMe PCIe 4.0 x4 HS SSD	Support	2
4XB7A13943	BNEF	ThinkSystem 2.5" U.2 P5520 7.68TB Read Intensive NVMe PCIe 4.0 x4 HS SSD	Support	2
4XB7A13631	BNEQ	ThinkSystem 2.5" U.2 P5520 15.36TB Read Intensive NVMe PCIe 4.0 x4 HS SSD	Support	2
4XB7A17145	BCFT	ThinkSystem 2.5" U.2 P5500 1.92TB Read Intensive NVMe PCIe 4.0 x4 HS SSD	No	2
2.5-inch SSDs - U.3 PCIe 4.0 NVMe - Read Intensive/Entry (<3 DWPD)				
4XB7A79646	BNF3	ThinkSystem 2.5" U.3 7450 PRO 960GB Read Intensive NVMe PCIe 4.0 x4 HS SSD	Support	2
4XB7A79647	BNF2	ThinkSystem 2.5" U.3 7450 PRO 1.92TB Read Intensive NVMe PCIe 4.0 x4 HS SSD	Support	2
4XB7A79648	BNF5	ThinkSystem 2.5" U.3 7450 PRO 3.84TB Read Intensive NVMe PCIe 4.0 x4 HS SSD	Support	2
4XB7A79649	BNF4	ThinkSystem 2.5" U.3 7450 PRO 7.68TB Read Intensive NVMe PCIe 4.0 x4 HS SSD	Support	2
4XB7A83097	BQAV	ThinkSystem 2.5" U.3 7450 PRO 15.36TB Read Intensive NVMe PCIe 4.0 x4 HS SSD	Support	2

Note: NVMe PCIe SSDs support surprise hot removal and hot insertion, provided the operating system supports PCIe SSD hot-swap.

Table 28. 2.5-inch hot-swap PCIe 3.0 NVMe SSDs

Part number	Feature code	Description	SED support	Max Qty
2.5-inch SSDs - U.2 PCIe 3.0 NVMe - Write Intensive/Performance (10+ DWPD)				
7N47A00081	AUMJ	ThinkSystem 2.5" U.2 P4800X 375GB Write Intensive NVMe PCIe 3.0 x4 HS SSD	No	2
2.5-inch SSDs - U.2 PCIe 3.0 NVMe - Mixed Use/Mainstream (3-5 DWPD)				
4XB7A13936	B589	ThinkSystem U.2 Intel P4610 1.6TB Mainstream NVMe PCIe3.0 x4 Hot Swap SSD	No	2
4XB7A13938	B58B	ThinkSystem U.2 Intel P4610 6.4TB Mainstream NVMe PCIe3.0 x4 Hot Swap SSD	No	2
2.5-inch SSDs - U.2 PCIe 3.0 NVMe - Read Intensive/Entry (<3 DWPD)				
4XB7A10202	B58F	ThinkSystem U.2 Intel P4510 1.0TB Entry NVMe PCIe3.0 x4 Hot Swap SSD	No	2
4XB7A10205	B58H	ThinkSystem U.2 Intel P4510 4.0TB Entry NVMe PCIe3.0 x4 Hot Swap SSD	No	2
4XB7A10175	B34N	ThinkSystem U.2 PM983 1.92TB Entry NVMe PCIe 3.0 x4 Hot Swap SSD	No	2
4XB7A10176	B34P	ThinkSystem U.2 PM983 3.84TB Entry NVMe PCIe 3.0 x4 Hot Swap SSD	No	2
4XB7A10177	B4D3	ThinkSystem U.2 PM983 7.68TB Entry NVMe PCIe3.0 x4 Hot Swap SSD	No	2

Note: NVMe PCIe SSDs support surprise hot removal and hot insertion, provided the operating system supports PCIe SSD hot-swap.

Table 29. M.2 SATA drives

Part number	Feature code	Description	SED support	Max Qty
M.2 SSDs - 6 Gb SATA - Read Intensive/Entry (<3 DWPD)				
4XB7A82286	BQ1Z	ThinkSystem M.2 5400 PRO 240GB Read Intensive SATA 6Gb NHS SSD	Support	2
4XB7A82287	BQ1Y	ThinkSystem M.2 5400 PRO 480GB Read Intensive SATA 6Gb NHS SSD	Support	2
7N47A00129	AUUL	ThinkSystem M.2 32GB SATA 6Gbps Non-Hot Swap SSD	No	2
7N47A00130	AUUV	ThinkSystem M.2 128GB SATA 6Gbps Non-Hot Swap SSD	No	2
4XB7A17071	B8HS	ThinkSystem M.2 5300 240GB SATA 6Gbps Non-Hot Swap SSD	No	2
4XB7A17073	B919	ThinkSystem M.2 5300 480GB SATA 6Gbps Non-Hot Swap SSD	No	2

Internal tape drives

The server does not support an internal tape drive. However, it can be attached to external tape drives by using Fibre Channel connectivity.

Optical drives

The server does not support an internal optical drive, however, you can connect an external USB optical drive. Alternatively, use the remote media feature of the XClarity Controller and the Chassis Management Module.

The server supports the external USB optical drive listed in the following table.

Table 30. External optical drive

Part number	Feature code	Description
7XA7A05926	AVV8	ThinkSystem External USB DVD RW Optical Disk Drive

The drive is based on the Lenovo Slim DVD Burner DB65 drive and supports the following formats: DVD-RAM, DVD-RW, DVD+RW, DVD+R, DVD-R, DVD-ROM, DVD-R DL, CD-RW, CD-R, CD-ROM.

Embedded 10Gb Network Adapter

The SN550 includes an embedded 4-port 10Gb Intel controller built into the system board. As listed in the [Models](#) section, some SN550 models include the Fabric Connector needed to connect the embedded controller to the midplane of the Flex System chassis. For models that do not include the Fabric Connector, it can be ordered and installed in the field. Ordering information is listed in the following table.

Table 31. Fabric Connector ordering information

Part number	Feature code	Description
7M27A03927	AUYN	Lenovo ThinkSystem Server Fabric Connector

The location of the fabric connector is shown below.

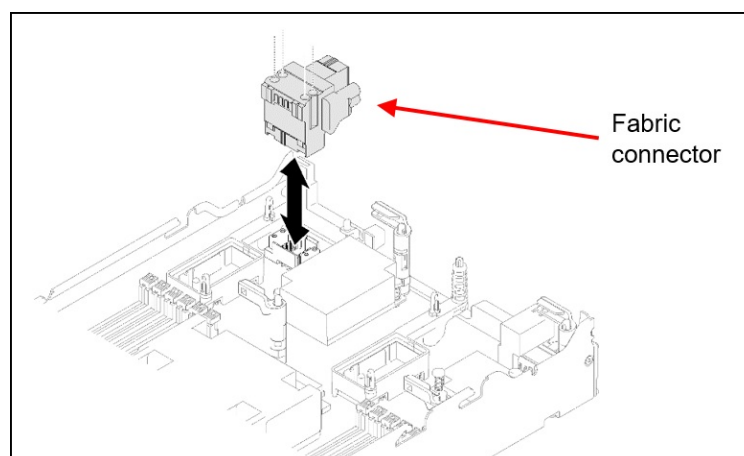

Figure 6. Location of fabric connector in SN550 server

Tip: To provide connectivity for all 4 adapter ports, make sure the associated chassis I/O module has adequate internal switch ports.

The [Adapter to I/O bay correspondence table](#) shows how the 4 ports of the embedded controller connect through the Fabric Connector to the corresponding switch ports. The Fabric Connector can be removed, if required, to allow the installation of an I/O adapter on I/O connector 1.

The embedded 10Gb controller is based on the Intel Ethernet Connection X722 network controller which is part of the Intel C624 "Lewisburg" PCH chipset of the SN550 and other Lenovo ThinkSystem servers.

The Intel X722 controller is optimized for data center, cloud, and mobile applications and includes the following features:

- **VXLAN/NVGRE Hardware Offloads:** These stateless offloads preserve application performance for overlay networks. With these offloads, it is possible to distribute network traffic across CPU cores. At the same time, the controller offloads LSO, GSO, and checksum from the host software, which reduces CPU overhead.
- **Low latency:** Intel Ethernet Flow Director delivers hardware-based application steering and Intel Data Direct I/O makes the processor cache the primary destination and source of I/O data rather than main memory.
- **Virtualization performance:** With Intel Virtualization Technology (VT), the controller delivers outstanding I/O performance in virtualized server environments. The controller reduces I/O bottlenecks by providing intelligent offloads for networking traffic per virtual machine (VM), which enables near-line rate speeds for small packets and supports almost an unlimited amount of isolated traffic flows so that you can scale your cloud environment.
- **Next-generation VMDq:** The controller supports up to 128 VMDq VMs and offers enhanced Quality of Service (QoS) by providing weighted round-robin servicing for the Tx data. The controller offloads the data-sorting functionality from the hypervisor to the network silicon, which improves data throughput and CPU usage.
- **SR-IOV implementation:** Provides an implementation of the PCI-SIG standard for I/O Virtualization. The physical configuration of each port is divided into multiple virtual ports. Each virtual port is assigned to an individual VM directly by bypassing the virtual switch in the Hypervisor, which results in near-native performance.
- **iWarp RDMA support** implements kernel bypass and direct data placement and allows for more efficient high-speed networking by eliminating queues and network related interrupts
- **VM load balancing:** Provides traffic load balancing (Tx and Rx) across VMs that are bound to the team interface. It also provides fault tolerance if a switch, port, or cable fails or is disconnected.
- **Auto-detect (PnP) feature** for the LOM adapters, enabling you to change speed (eg from a 1Gb LOM to 10 Gb LOM) and the network interface will automatically reconfigure during the boot process.

Note: The onboard Ethernet controller does not support 10 Mb or 100 Mb Ethernet connections.

I/O expansion options

The SN550 has two I/O expansion connectors for attaching I/O adapter cards. The I/O expansion connectors use a high-density, 216-pin PCIe connection. Installing I/O adapter cards allows the server to connect with switch modules in the chassis. Each slot has a PCI Express 3.0 x16 host interface and both slots support the same form-factor adapters. If the SN550 has a Fabric Connector in adapter slot 1, it must be removed first to use that slot for an optional I/O adapter.

The following figure shows the location of the I/O expansion connectors.

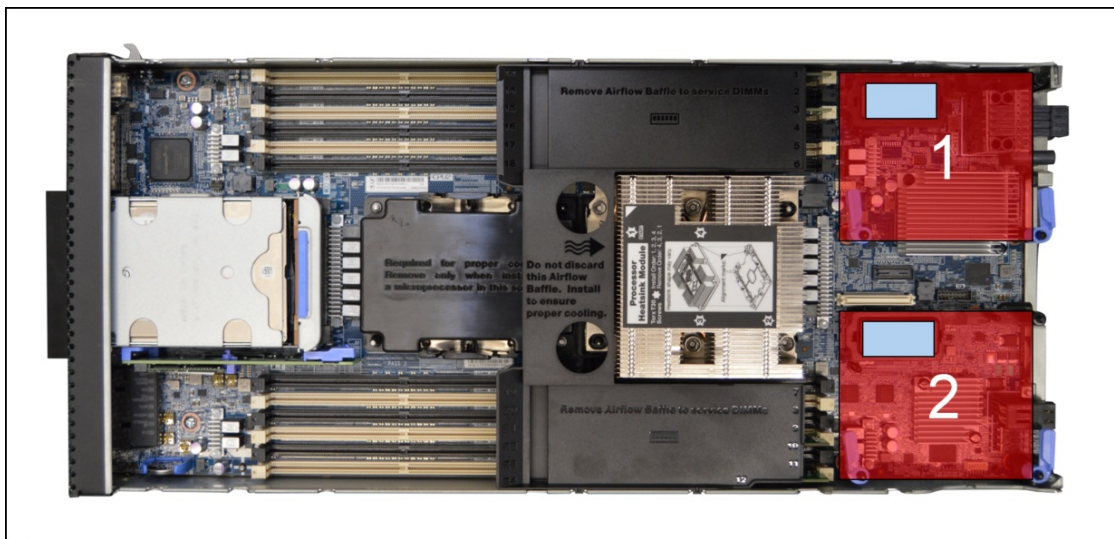

Figure 7. Location of the I/O adapter slots in the ThinkSystem SN550 server

A compatible switch or pass-through module must be installed in the corresponding I/O bays in the chassis, as indicated in the following table. Installing two switches means that all ports of the adapter are enabled, which improves performance and network availability.

Table 32. Adapter to I/O bay correspondence

I/O adapter slot in the server	Port on the adapter	Corresponding I/O module bay in the chassis
Slot 1	Port 1	Module bay 1
	Port 2	Module bay 2
	Port 3 (for 4-port cards)	Module bay 1
	Port 4 (for 4-port cards)	Module bay 2
Slot 2	Port 1	Module bay 3
	Port 2	Module bay 4
	Port 3 (for 4-port cards)	Module bay 3
	Port 4 (for 4-port cards)	Module bay 4

The following figure shows the location of the I/O module bays in the Flex System Enterprise Chassis.

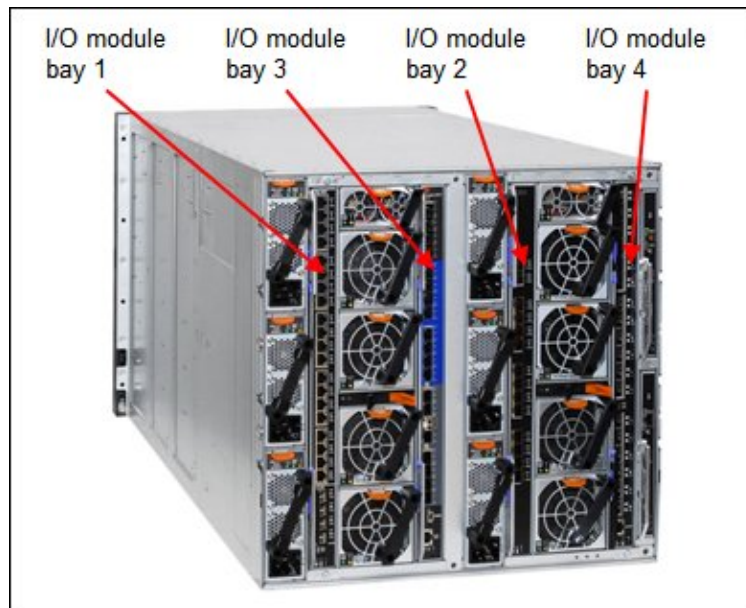

Figure 8. Location of the I/O module bays in the Flex System Enterprise Chassis

The following figure shows how adapters are connected to I/O modules that are installed in the chassis.

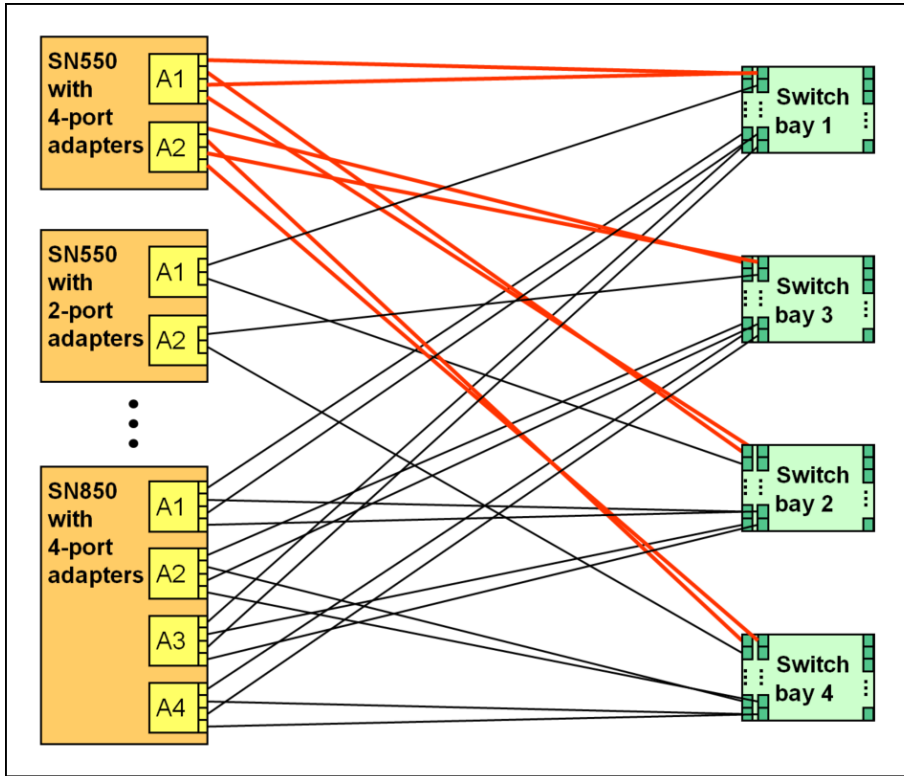

Figure 9. Logical layout of the interconnects between I/O adapters and I/O modules

Network adapters

In addition to the embedded Intel 4-port 10Gb controller (model specific), the SN550 supports other network adapters that can be installed in IO slots.

The following table lists the supported network adapters and upgrades. Adapters can be installed in either slot. However, compatible I/O modules must be installed in the corresponding bays of the chassis.

Operating system support: The following adapters do not support the latest operating systems (ESXi 8.x, RHEL 9.x, SLES 16.x):

- ThinkSystem QLogic QL45214 Flex 25Gb 4-Port Ethernet Adapter, 7XC7A05844
- ThinkSystem QLogic QL45212 Flex 50Gb 2-Port Ethernet Adapter, 7XC7A05843
- ThinkSystem QLogic QL45262 Flex 50Gb 2-Port Ethernet Adapter with iSCSI/FCoE, 7XC7A05845

See the product guides for the adapters or [ServerProven](#) for the list of supported OSES for these adapters.

Table 33. Network adapters

Part number	Feature code	Description
50 Gb Ethernet		
7XC7A05843	B2VT	ThinkSystem QLogic QL45212 Flex 50Gb 2-Port Ethernet Adapter
7XC7A05845	B2VV	ThinkSystem QLogic QL45262 Flex 50Gb 2-Port Ethernet Adapter with iSCSI/FCoE
25 Gb Ethernet		
7XC7A05844	B2VU	ThinkSystem QLogic QL45214 Flex 25Gb 4-Port Ethernet Adapter
4XC7A08315	BHBX	ThinkSystem Mellanox ConnectX-4 Lx 25Gb 2-port Mezz Adapter
10 Gb Ethernet		
00AG540	ATBT	Flex System CN4052S 2-port 10Gb Virtual Fabric Adapter
00AG590	ATBS	Flex System CN4054S 4-port 10Gb Virtual Fabric Adapter

For more details about these adapters, see the Lenovo Press product guides in the Network adapters category: <https://lenovopress.com/servers/blades/nic>

For more information about adapter-to-switch compatibility, see the Flex System Interoperability Guide: <http://lenovopress.com/fsig>

Storage host bus adapters

The following table lists storage HBAs that are supported by the SN550. Storage HBAs are supported in both slots, however for CTO orders, an HBA is installed only in slot 2.

Operating system support: The following adapters do not support the latest operating systems (ESXi 8.x, RHEL 9.x, SLES 16.x):

- ThinkSystem Emulex LPm16002B-L Mezz 16Gb 2-Port Fibre Channel Adapter, 7ZT7A00521
- ThinkSystem Emulex LPm16004B-L Mezz 16Gb 4-Port Fibre Channel Adapter, 7ZT7A00522

See the product guides for the adapters or [ServerProven](#) for the list of supported OSES for these adapters.

Table 34. Storage host bus adapters

Part number	Feature code	Description
7ZT7A00520	AVCV	ThinkSystem QLogic QML2692 Mezz 16Gb 2-Port Fibre Channel Adapter
7ZT7A00521	AVCW	ThinkSystem Emulex LPm16002B-L Mezz 16Gb 2-Port Fibre Channel Adapter

For details about these adapters, see the Lenovo Press product guides in the Storage adapters category: <https://lenovopress.com/servers/blades/hba>

For more information about adapter-to-switch compatibility, see the Flex System Interoperability Guide: <http://lenovopress.com/fsig>

Power supplies

Power to the blade server is derived from the power supplies that are installed in the chassis. There are no server options regarding power supplies.

System Management

The server contains an integrated service processor, XClarity Controller (XCC), which provides advanced service-processor control, monitoring, and alerting functions. The XCC is based on the Pilot4 XE401 baseboard management controller (BMC) using a dual-core ARM Cortex A9 service processor.

Local management

As shown in [Figure 2](#), the SN550 front panel includes a USB port, status indicators, a button to enable management via the USB port and a console breakout cable port. The breakout cable supplied with the chassis provides serial, video and a USB port for connecting a local console. The USB ports on the breakout cable support keyboard and mouse; storage devices are not supported.

System status with XClarity Mobile

The Lenovo XClarity Mobile (LXCM) app now includes a tethering function where you can connect your Android or iOS device to the server via USB to see the status of the server.

The steps to connect the mobile device are as follows:

1. Enable USB Management on the server, by pressing and holding for 3 seconds the dedicated USB management button on the front of the server.
2. Connect the mobile device via a USB cable to the server's USB port with the management symbol
3. In iOS or Android settings, enable Personal Hotspot or USB Tethering
4. Launch the Lenovo XClarity Mobile app

Once connected you can see the following information:

- Server status including error logs (read only, no login required)
- Server management functions (XClarity login credentials required)

Light Path Diagnostics

The SN550 includes light path diagnostics. If an environmental condition exceeds a threshold or if a system component fails, XCC lights LEDs inside the server to help you diagnose the problem and find the failing part.

For quick problem determination when you are physically at the server, the server offers the following three-step guided path:

- Illuminate the fault LED on the front panel.
- Identify the fault in the light path diagnostics panel, as shown in the following figure.
- If a DIMM is faulty, the LED next to it is illuminated.

The SN550 light path diagnostics panel is inside the server near the front panel, as shown in the following figure.

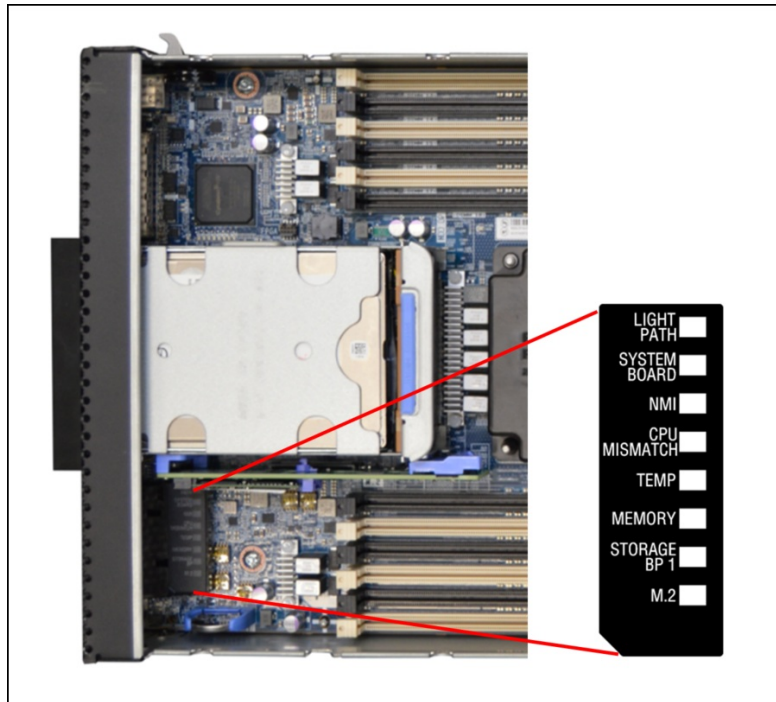

Figure 10. Location of SN550 light path diagnostics panel

To illuminate the light path diagnostics LEDs, power off the server, slide it out of the chassis, and press and hold the power button. The power button doubles as the light path diagnostics reminder button when the server is removed from the chassis.

The meanings of the LEDs in the light path diagnostics panel are listed in the following table.

Table 35. Light path diagnostic panel LEDs

LED	Meaning
LIGHT PATH	The light path diagnostics panel is operational.
SYSTEM BOARD	A system board error is detected.
NMI	A non-maskable interrupt (NMI) occurred.
CPU MISMATCH	The processors are mismatched.
TEMP	An over-temperature condition occurred that was critical enough to shut down the server.
MEMORY	A memory fault occurred. The corresponding DIMM error LEDs on the system board are also lit.
STORAGE BP 1	A hard disk drive backplane error has occurred.
M.2	A M.2 error has occurred.

The front of the server also houses an information pull-out tab. See [Figure 2](#) for the location. A label on the tab shows the network information (MAC address and other data) to remotely access XClarity Controller.

Remote management

Lenovo XClarity Controller (XCC) is an embedded management engine common in every ThinkSystem server.

There are two ways to access the management processor:

- Command-line interface. To access the CLI interface, use SSH to log in to the management processor.
- Web-based interface. To access the web-based interface, point your browser to the IP address for the management processor. The intuitive interface includes at-a-glance visualizations and simple access to common system actions. The dashboard is shown in the following figure.

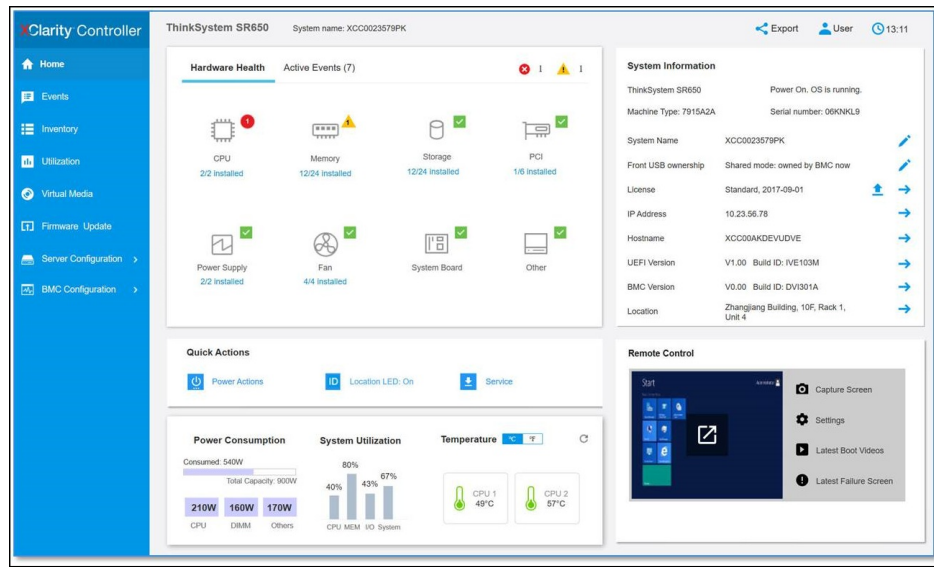

Figure 11. Lenovo XClarity Controller dashboard

Remote server management is provided through industry-standard interfaces:

- Intelligent Platform Management Interface (IPMI) Version 2.0
- Simple Network Management Protocol (SNMP) Version 3 (no SET commands; no SMNP v1)
- Common Information Model (CIM-XML)
- Representational State Transfer (REST) support
- Redfish support (DMTF compliant)
- Web browser - HTML 5-based browser interface (Java and ActiveX not required) using a responsive design (content optimized for device being used - laptop, tablet, phone) with NLS support

IPMI via the Ethernet port (IPMI over LAN) is supported, however it is disabled by default. For CTO orders you can specify whether you want the feature enabled or disabled in the factory, using the feature codes listed in the following table.

Table 36. IPMI-over-LAN settings

Part number	Feature code	Description
CTO only	B7XZ	Disable IPMI-over-LAN (default)
CTO only	B7Y0	Enable IPMI-over-LAN

Virtual presence (remote control) and virtual media capability also come standard in the SN550. The remote control functions include the following:

- Remotely viewing video with graphics resolutions up to 1600x1200 at 75 Hz with up to 32 bits per pixel, regardless of the system state
- Remotely accessing the server using the keyboard and mouse from a remote client
- Capturing blue-screen errors
- International keyboard mapping support
- LDAP-based authentication
- Remote mounting of ISO and diskette IMG image files as virtual drives that are available for use by the server
- Boot Capture
- Virtual console collaboration - Ability for up to 6 remote users to be log into the remote session simultaneously
- Power capping

Lenovo XClarity Energy Manager

Lenovo XClarity Energy Manager (LXEM) is an agent-less, web-based console that provides power management for ThinkServer, System x and ThinkSystem servers. It enables server density and data center capacity to be increased through the use of power capping.

LXEM is a licensed product. A single-node LXEM license is included with the XClarity Controller Enterprise (XCC Enterprise) version. Because the Enterprise version of XCC is standard in the SN550, a license for XClarity Energy Manager is included. For more information on LXEM, please see the User Guide: <http://datacentersupport.lenovo.com/us/en/downloads/ds101160>

Lenovo XClarity Administrator

Lenovo XClarity Administrator is a centralized resource management solution designed to reduce complexity, speed response, and enhance the availability of Lenovo systems and solutions. It provides agent-free hardware management for ThinkSystem servers, in addition to ThinkServer, System x, and Flex System servers. The administration dashboard is based on HTML 5 and allows fast location of resources so tasks can be run quickly.

Because Lenovo XClarity Administrator does not require any agent software to be installed on the managed endpoints, there are no CPU cycles spent on agent execution, and no memory is used, which means that up to 1GB of RAM and 1 - 2% CPU usage is saved, compared to a typical managed system where an agent is required.

Lenovo XClarity Administrator is an optional software component for the SN550. The software can be downloaded and used at no charge to discover and monitor the SN550 and to manage firmware upgrades.

If software support is required for Lenovo XClarity Administrator, or premium features such as configuration management and operating system deployment are required, Lenovo XClarity Pro software subscription should be ordered. Lenovo XClarity Pro is licensed on a per managed system basis, that is, each managed Lenovo system requires a license.

The following table lists the geo-specific Lenovo XClarity software license options.

Table 37. Lenovo XClarity software options

Part number (NA, AP, Japan markets)	Part number (EMEA, LA markets)	Description
00MT201	00MT207	Lenovo XClarity Pro, per Managed Endpoint w/1 Yr SW S&S
00MT202	00MT208	Lenovo XClarity Pro, per Managed Endpoint w/3 Yr SW S&S
00MT203	00MT209	Lenovo XClarity Pro, per Managed Endpoint w/5 Yr SW S&S

Lenovo XClarity Administrator offers the following standard features that are available at no charge:

- Auto-discovery and monitoring of Lenovo systems
- Firmware updates and compliance enforcement
- External alerts and notifications via SNMP traps, syslog remote logging, and e-mail
- Secure connections to managed endpoints
- NIST 800-131A or FIPS 140-2 compliant cryptographic standards between the management solution and managed endpoints
- Integration into existing higher-level management systems such as cloud automation and orchestration tools through REST APIs, providing extensive external visibility and control over hardware resources
- An intuitive, easy-to-use GUI
- Scripting with Windows PowerShell, providing command-line visibility and control over hardware resources

Lenovo XClarity Administrator offers the following premium features that require an optional Pro license:

- Pattern-based configuration management that allows to define configurations once and apply repeatedly without errors when deploying new servers or redeploying existing servers without disrupting the fabric
- Bare-metal deployment of operating systems and hypervisors to streamline infrastructure provisioning

For more information, refer to the Lenovo XClarity Administrator Product Guide:

<http://lenovopress.com/tips1200>

Lenovo XClarity Integrators

Lenovo also offers software plug-in modules, Lenovo XClarity Integrators, to manage physical infrastructure from leading external virtualization management software tools including those from Microsoft and VMware.

These integrators are offered at no charge, however if software support is required, a Lenovo XClarity Pro software subscription license should be ordered.

Lenovo XClarity Integrators offer the following additional features:

- Ability to discover, manage, and monitor Lenovo server hardware from VMware vCenter or Microsoft System Center
- Deployment of firmware updates and configuration patterns to Lenovo x86 rack servers and Flex System from the virtualization management tool
- Non-disruptive server maintenance in clustered environments that reduces workload downtime by dynamically migrating workloads from affected hosts during rolling server updates or reboots
- Greater service level uptime and assurance in clustered environments during unplanned hardware events by dynamically triggering workload migration from impacted hosts when impending hardware failures are predicted

For more information about all the available Lenovo XClarity Integrators, see the Lenovo XClarity Administrator Product Guide: <https://lenovopress.com/tips1200-lenovo-xclarity-administrator>

Lenovo XClarity Provisioning Manager

Lenovo XClarity Provisioning Manager (LXPM) is a UEFI-based application embedded in ThinkSystem servers and accessible via the F1 key during system boot.

LXPM provides the following functions:

- Graphical UEFI Setup
- System inventory information and VPD update
- System firmware updates (UEFI and XCC)
- RAID setup wizard
- OS installation wizard (including unattended OS installation)
- Diagnostics functions

Lenovo XClarity Essentials

Lenovo offers the following XClarity Essentials software tools that can help you set up, use, and maintain the server at no additional cost:

- **Lenovo Essentials OneCLI**

OneCLI is a collection of server management tools that uses a command line interface program to manage firmware, hardware, and operating systems. It provides functions to collect full system health information (including health status), configure system settings, and update system firmware and drivers.

- **Lenovo Essentials UpdateXpress**

The UpdateXpress tool is a standalone GUI application for firmware and device driver updates that enables you to maintain your server firmware and device drivers up-to-date and help you avoid unnecessary server outages. The tool acquires and deploys individual updates and UpdateXpress System Packs (UXSPs) which are integration-tested bundles.

- **Lenovo Essentials Bootable Media Creator**

The Bootable Media Creator (BOMC) tool is used to create bootable media for offline firmware update.

For more information and downloads, visit the Lenovo XClarity Essentials web page:

<http://support.lenovo.com/us/en/documents/LNVO-center>

Security

The server offers the following security features:

- Administrator and power-on password
- Trusted Platform Module (TPM) supporting both TPM 1.2 and TPM 2.0
- Optional plugin Trusted Cryptographic Module (TCM) or Nationz TPM, available only in China
- Support for IBM Security Key Lifecycle Manager (SKLM) as described in the [Internal storage](#) section

The server is NIST SP 800-147B compliant.

The TCM and TPM plugin modules, available only for China customers, are installed in a dedicated socket on the system board, as shown in [Figure 3](#). Ordering information is shown in the following table.

Table 38. Security features

Part number	Feature code	Description
None*	AVKE	ThinkSystem Trusted Cryptographic Module (China customers only)
None*	B22N	ThinkSystem Nationz Trusted Platform Module v2.0 (China customers only)

* Available configure-to-order or pre-configured models only; Not available as a field upgrade.

Intel Transparent Supply Chain

Add a layer of protection in your data center and have peace of mind that the server hardware you bring into it is safe authentic and with documented, testable, and provable origin.

Lenovo has one of the world's best supply chains, as ranked by Gartner Group, backed by extensive and mature supply chain security programs that exceed industry norms and US Government standards. Now we are the first Tier 1 manufacturer to offer Intel® Transparent Supply Chain in partnership with Intel, offering you an unprecedented degree of supply chain transparency and assurance.

To enable Intel Transparent Supply Chain for the Intel-based servers in your order, add the following feature code in the [DCSC configurator](#), under the Security tab.

Table 39. Intel Transparent Supply Chain ordering information

Feature code	Description
BB0P	Intel Transparent Supply Chain

For more information on this offering, see the paper *Introduction to Intel Transparent Supply Chain on Lenovo ThinkSystem Servers*, available from <https://lenovopress.com/lp1434-introduction-to-intel-transparent-supply-chain-on-thinksystem-servers>.

Operating systems

The server supports the following operating systems:

- Microsoft Windows Server 2016
- Microsoft Windows Server 2019
- Microsoft Windows Server 2022
- Red Hat Enterprise Linux 7.6
- Red Hat Enterprise Linux 7.7
- Red Hat Enterprise Linux 7.8
- Red Hat Enterprise Linux 7.9
- Red Hat Enterprise Linux 8.0
- Red Hat Enterprise Linux 8.1
- Red Hat Enterprise Linux 8.2
- Red Hat Enterprise Linux 8.3
- Red Hat Enterprise Linux 8.4
- Red Hat Enterprise Linux 8.5
- Red Hat Enterprise Linux 8.6

- Red Hat Enterprise Linux 8.7
- Red Hat Enterprise Linux 9.0
- Red Hat Enterprise Linux 9.1
- SUSE Linux Enterprise Server 12 SP4
- SUSE Linux Enterprise Server 12 SP5
- SUSE Linux Enterprise Server 12 Xen SP4
- SUSE Linux Enterprise Server 12 Xen SP5
- SUSE Linux Enterprise Server 15
- SUSE Linux Enterprise Server 15 SP1
- SUSE Linux Enterprise Server 15 SP2
- SUSE Linux Enterprise Server 15 SP3
- SUSE Linux Enterprise Server 15 SP4
- SUSE Linux Enterprise Server 15 Xen
- SUSE Linux Enterprise Server 15 Xen SP1
- SUSE Linux Enterprise Server 15 Xen SP2
- SUSE Linux Enterprise Server 15 Xen SP3
- SUSE Linux Enterprise Server 15 Xen SP4
- Ubuntu 22.04 LTS 64-bit
- VMware ESXi 6.5 U2
- VMware ESXi 6.5 U3
- VMware ESXi 6.7 U1
- VMware ESXi 6.7 U2
- VMware ESXi 6.7 U3
- VMware ESXi 7.0
- VMware ESXi 7.0 U1
- VMware ESXi 7.0 U2
- VMware ESXi 7.0 U3
- VMware ESXi 8.0

For a complete list of supported, certified and tested operating systems, plus additional details and links to relevant web sites, see the Operating System Interoperability Guide: <https://lenovopress.com/osig#servers=sn550-7x16-sp-gen-2>

For configure-to-order configurations, the server can be preloaded with VMware ESXi installed on M.2 cards. Ordering information is listed in the following table.

Table 40. VMware ESXi preload

Part number	Feature code	Description
CTO only	B3VW	VMware ESXi 6.5 U2 (Factory Installed)
CTO only	B6U0	VMware ESXi 6.5 U3 (factory installed)
CTO only	B4XA	VMware ESXi 6.7 U1 (Factory Installed)
CTO only	B6U1	VMware ESXi 6.7 U2 (factory installed)
CTO only	B88T	VMware ESXi 6.7 U3 (factory installed)
CTO only	BBZG	VMware ESXi 7.0 (Factory Installed)
CTO only	BE5E	VMware ESXi 7.0 U1 (Factory Installed)
CTO only	BHSR	VMware ESXi 7.0 U2 (Factory Installed)
CTO only	BMEY	VMware ESXi 7.0 U3 (Factory Installed)
CTO only	BMT5	VMware ESXi 8.0 (Factory Installed)

Physical specifications

The server features the following dimensions and weight (approximate):

- Width: 218 mm (8.5 in)
- Height: 56 mm (2.2 in)
- Depth: 507 mm (20.0 in)
- Maximum weight: 7.1 kg (15.6 lb)

The shipping dimensions (cardboard packaging) of the SN550 are as follows:

- Width: 430 mm (16.9 inches)
- Height: 201 mm (7.9 inches)
- Depth: 610 mm (24.0 inches)

Operating environment

The Lenovo ThinkSystem SN550 server complies with ASHRAE Class A3 specifications. System performance may be impacted when operating temperature is above ASHRAE A3 specification or fan failed condition.

Temperature and humidity

The server is supported in the following environment:

- Air temperature:
 - Operating:
 - ASHRAE Class A2: 10 °C - 35 °C (50 °F - 95 °F); decrease the maximum ambient temperature by 1 °C for every 300 m (984 ft) increase in altitude above 900 m (2,953 ft)
 - ASHRAE Class A3: 5 °C - 40 °C (41 °F - 104 °F); decrease the maximum ambient temperature by 1 °C for every 175 m (574 ft) increase in altitude above 900 m (2,953 ft)
 - Server off: 5°C to 45°C (41°F to 113°F)
 - Shipment/Storage: -40 °C to 60 °C (-40 °F to 140 °F)
- Maximum altitude: 3,050 m (10,000 ft)
- Relative Humidity (non-condensing):
 - Operating:
 - ASHRAE Class A2: 8% - 80%, maximum dew point: 21°C (70°F)
 - ASHRAE Class A3: 8% - 85%, maximum dew point: 24°C (75°F)
 - Shipment/Storage: 8% - 90%

Shock and vibration:

The server, installed in the Enterprise Chassis, has the following vibration and shock limits:

- Vibration:
 - Operating: 0.21 G rms at 5 Hz to 500 Hz for 15 minutes across 3 axes
 - Non-operating: 1.04 G rms at 2 Hz to 200 Hz for 15 minutes across 6 surfaces
- Shock:
 - Operating: 15 G for 3 milliseconds in each direction ($\pm X, \pm Y, \pm Z$ axes, total 6 shocks)
 - Non-operating, based on weight of the system (server with/without chassis):
 - Less than 4 kg: 50 G for 180 inches/sec velocity change across 6 surfaces (total 6 shocks)
 - 4 kg to 12 kg: 50 G for 167 inches/sec velocity change across 6 surfaces (total 6 shocks)
 - 12 kg to 23 kg: 50 G for 152 inches/sec velocity change across 6 surfaces (total 6 shocks)
 - 23 kg to 32 kg: 35 G for 152 inches/sec velocity change across 6 surfaces (total 6 shocks)
 - 32 kg to 69 kg: 35 G for 136 inches/sec velocity change across 6 surfaces (total 6 shocks)
 - 69 kg and above: 25 G for 118 inches/sec velocity change across 6 surfaces (total 6 shocks)

Particulate contamination

Airborne particulates (including metal flakes or particles) and reactive gases acting alone or in combination with other environmental factors such as humidity or temperature might damage the system that might cause the system to malfunction or stop working altogether.

The following specifications indicate the limits of particulates that the system can tolerate:

- Reactive gases:
 - The reactivity rate of copper coupons shall be less than 200 Angstroms per month ($\text{Å}/\text{month}$)
 - The reactivity rate of silver coupons shall be less than 200 $\text{Å}/\text{month}$
- Airborne particulates:
 - The room air should be continuously filtered with MERV 8 filters.
 - Air entering a data center should be filtered with MERV 11 or preferably MERV 13 filters.
 - The deliquescent relative humidity of the particulate contamination should be more than 60% RH
 - Data centers must be free of zinc whiskers

For additional information, see the Specifications section of the Setup Guide for the server, available from the Lenovo ThinkSystem Information Center, <https://thinksystem.lenovofiles.com/help/index.jsp>

Warranty and Support

The ThinkSystem SN550 (machine type 7X16) has a 3-year warranty.

The standard warranty terms are customer-replaceable unit (CRU) and onsite (for field-replaceable units FRUs only) with standard call center support during normal business hours and 9x5 Next Business Day Parts Delivered.

Lenovo's additional support services provide a sophisticated, unified support structure for your data center, with an experience consistently ranked number one in customer satisfaction worldwide. Available offerings include:

- **Premier Support**

Premier Support provides a Lenovo-owned customer experience and delivers direct access to technicians skilled in hardware, software, and advanced troubleshooting, in addition to the following:

- Direct technician-to-technician access through a dedicated phone line
- 24x7x365 remote support
- Single point of contact service
- End to end case management
- Third-party collaborative software support
- Online case tools and live chat support
- On-demand remote system analysis

- **Warranty Upgrade (Preconfigured Support)**

Services are available to meet the on-site response time targets that match the criticality of your systems.

- 3, 4, or 5 years of service coverage
- 1-year or 2-year post-warranty extensions
- **Foundation Service:** 9x5 service coverage with next business day onsite response. YourDrive YourData is an optional extra (see below).
- **Essential Service:** 24x7 service coverage with 4-hour onsite response or 24-hour committed repair (available only in select markets). Bundled with YourDrive YourData.
- **Advanced Service:** 24x7 service coverage with 2-hour onsite response or 6-hour committed repair (available only in select markets). Bundled with YourDrive YourData.

- **Managed Services**

Lenovo Managed Services provides continuous 24x7 remote monitoring (plus 24x7 call center availability) and proactive management of your data center using state-of-the-art tools, systems, and practices by a team of highly skilled and experienced Lenovo services professionals.

Quarterly reviews check error logs, verify firmware & OS device driver levels, and software as needed. We'll also maintain records of latest patches, critical updates, and firmware levels, to ensure you systems are providing business value through optimized performance.

- **Technical Account Management (TAM)**

A Lenovo Technical Account Manager helps you optimize the operation of your data center based on a deep understanding of your business. You gain direct access to your Lenovo TAM, who serves as your single point of contact to expedite service requests, provide status updates, and furnish reports to track incidents over time. In addition, your TAM will help proactively make service recommendations and manage your service relationship with Lenovo to make certain your needs are met.

- **Enterprise Server Software Support**

Enterprise Software Support is an additional support service providing customers with software support on Microsoft, Red Hat, SUSE, and VMware applications and systems. Around the clock availability for critical problems plus unlimited calls and incidents helps customers address challenges fast, without incremental costs. Support staff can answer troubleshooting and diagnostic questions, address product comparability and interoperability issues, isolate causes of problems, report defects to software vendors, and more.

- **YourDrive YourData**

Lenovo's YourDrive YourData is a multi-drive retention offering that ensures your data is always under your control, regardless of the number of drives that are installed in your Lenovo server. In the unlikely event of a drive failure, you retain possession of your drive while Lenovo replaces the failed drive part. Your data stays safely on your premises, in your hands. The YourDrive YourData service can be purchased in convenient bundles and is optional with Foundation Service. It is bundled with Essential Service and Advanced Service.

- **Health Check**

Having a trusted partner who can perform regular and detailed health checks is central to maintaining efficiency and ensuring that your systems and business are always running at their best. Health Check supports Lenovo-branded server, storage, and networking devices, as well as select Lenovo-supported products from other vendors that are sold by Lenovo or a Lenovo-Authorized Reseller.

Examples of region-specific warranty terms are second or longer business day parts delivery or parts-only base warranty.

If warranty terms and conditions include onsite labor for repair or replacement of parts, Lenovo will dispatch a service technician to the customer site to perform the replacement. Onsite labor under base warranty is limited to labor for replacement of parts that have been determined to be field-replaceable units (FRUs). Parts that are determined to be customer-replaceable units (CRUs) do not include onsite labor under base warranty.

If warranty terms include parts-only base warranty, Lenovo is responsible for delivering only replacement parts that are under base warranty (including FRUs) that will be sent to a requested location for self-service. Parts-only service does not include a service technician being dispatched onsite. Parts must be changed at customer's own cost and labor and defective parts must be returned following the instructions supplied with the spare parts.

Lenovo Service offerings are region-specific. Not all preconfigured support and upgrade options are available in every region. For information about Lenovo service upgrade offerings that are available in your region, refer to the following resources:

- Service part numbers in Lenovo Data Center Solution Configurator (DCSC):
<http://dcsc.lenovo.com/#!/services>
- Lenovo Services Availability Locator
<http://lenovocator.com/>

For service definitions, region-specific details, and service limitations, please refer to the following documents:

- Lenovo Statement of Limited Warranty for Infrastructure Solutions Group (ISG) Servers and System Storage
<http://pcsupport.lenovo.com/us/en/solutions/ht503310>
- Lenovo Data Center Services Agreement
<http://support.lenovo.com/us/en/solutions/ht116628>

Services

Lenovo Services is a dedicated partner to your success. Our goal is to reduce your capital outlays, mitigate your IT risks, and accelerate your time to productivity.

Note: Some service options may not be available in all markets or regions. For more information, go to <https://www.lenovo.com/services>. For information about Lenovo service upgrade offerings that are available in your region, contact your local Lenovo sales representative or business partner.

Here's a more in-depth look at what we can do for you:

- **Asset Recovery Services**

Asset Recovery Services (ARS) helps customers recover the maximum value from their end-of-life equipment in a cost-effective and secure way. On top of simplifying the transition from old to new equipment, ARS mitigates environmental and data security risks associated with data center equipment disposal. Lenovo ARS is a cash-back solution for equipment based on its remaining market value, yielding maximum value from aging assets and lowering total cost of ownership for your customers. For more information, see the ARS page, <https://lenovopress.com/lp1266-reduce-e-waste-and-grow-your-bottom-line-with-lenovo-ars>.

- **Assessment Services**

An Assessment helps solve your IT challenges through an onsite, multi-day session with a Lenovo technology expert. We perform a tools-based assessment which provides a comprehensive and thorough review of a company's environment and technology systems. In addition to the technology based functional requirements, the consultant also discusses and records the non-functional business requirements, challenges, and constraints. Assessments help organizations like yours, no matter how large or small, get a better return on your IT investment and overcome challenges in the ever-changing technology landscape.

- **Design Services**

Professional Services consultants perform infrastructure design and implementation planning to support your strategy. The high-level architectures provided by the assessment service are turned into low level designs and wiring diagrams, which are reviewed and approved prior to implementation. The implementation plan will demonstrate an outcome-based proposal to provide business capabilities through infrastructure with a risk-mitigated project plan.

- **Basic Hardware Installation**

Lenovo experts can seamlessly manage the physical installation of your server, storage, or networking hardware. Working at a time convenient for you (business hours or off shift), the technician will unpack and inspect the systems on your site, install options, mount in a rack cabinet, connect to power and network, check and update firmware to the latest levels, verify operation, and dispose of the packaging, allowing your team to focus on other priorities.

- **Deployment Services**

When investing in new IT infrastructures, you need to ensure your business will see quick time to value with little to no disruption. Lenovo deployments are designed by development and engineering teams who know our Products & Solutions better than anyone else, and our technicians own the process from delivery to completion. Lenovo will conduct remote preparation and planning, configure & integrate systems, validate systems, verify and update appliance firmware, train on administrative tasks, and provide post-deployment documentation. Customer's IT teams leverage our skills to enable IT staff to transform with higher level roles and tasks.

- **Integration, Migration, and Expansion Services**

Move existing physical & virtual workloads easily, or determine technical requirements to support increased workloads while maximizing performance. Includes tuning, validation, and documenting ongoing run processes. Leverage migration assessment planning documents to perform necessary migrations.

Regulatory compliance

The server conforms to the following standards:

- ASHRAE Class A3
- FCC - Verified to comply with Part 15 of the FCC Rules Class A
- Canada ICES-004, issue 3 Class A
- UL/IEC 60950-1
- CSA C22.2 No. 60950-1
- Japan VCCI, Class A
- IEC 60950-1 (CB Certificate and CB Test Report)
- Taiwan BSMI CNS13438, Class A; CNS14336
- Australia/New Zealand AS/NZS CISPR 22, Class A
- Korea KN22, Class A, KN24
- IEC 60950-1 (CB Certificate and CB Test Report)
- CE Mark (EN55022 Class A, EN60950-1, EN55024, EN61000-3-2, EN61000-3-3)
- TUV-GS (EN60950-1/IEC 60950-1, EK1-ITB2000)

Lenovo Financial Services

Lenovo Financial Services reinforces Lenovo's commitment to deliver pioneering products and services that are recognized for their quality, excellence, and trustworthiness. Lenovo Financial Services offers financing solutions and services that complement your technology solution anywhere in the world.

We are dedicated to delivering a positive finance experience for customers like you who want to maximize your purchase power by obtaining the technology you need today, protect against technology obsolescence, and preserve your capital for other uses.

We work with businesses, non-profit organizations, governments and educational institutions to finance their entire technology solution. We focus on making it easy to do business with us. Our highly experienced team of finance professionals operates in a work culture that emphasizes the importance of providing outstanding customer service. Our systems, processes and flexible policies support our goal of providing customers with a positive experience.

We finance your entire solution. Unlike others, we allow you to bundle everything you need from hardware and software to service contracts, installation costs, training fees, and sales tax. If you decide weeks or months later to add to your solution, we can consolidate everything into a single invoice.

Our Premier Client services provide large accounts with special handling services to ensure these complex transactions are serviced properly. As a premier client, you have a dedicated finance specialist who manages your account through its life, from first invoice through asset return or purchase. This specialist develops an in-depth understanding of your invoice and payment requirements. For you, this dedication provides a high-quality, easy, and positive financing experience.

For your region-specific offers, please ask your Lenovo sales representative or your technology provider about the use of Lenovo Financial Services. For more information, see the following Lenovo website:

<https://www.lenovo.com/us/en/landingpage/lenovo-financial-services/>

Related publications and links

For more information, see the following resources:

- ThinkSystem SN550 server product page
<https://www.lenovo.com/us/en/data-center/servers/flex-blade-servers/compute-nodes/ThinkSystem-SN550/p/77XX7FSFS55>
- Interactive 3D Tour of the ThinkSystem SN550
<https://lenovopress.com/lp0668-3d-tour-thinksystem-sn550>
- ThinkSystem SN550 drivers and support
<http://datacentersupport.lenovo.com/products/servers/thinksystem/sn550/7x16/downloads>
- Lenovo ThinkSystem SN550 product publications:
https://thinksystem.lenovofiles.com/help/topic/7X16/introduction.html?cp=1_0
 - Quick Start
 - Rack Installation Guide
 - Setup Guide
 - Hardware Maintenance Manual
 - Messages and Codes Reference
 - Memory Population Reference
- Lenovo Hardware Installation & Removal Videos on the ThinkSystem SN550:
 - YouTube: https://www.youtube.com/playlist?list=PLYV5R7hVcs-B4_LYuT9X1MRWBU6UzX9gO
 - Youku: https://list.youku.com/albumlist/show/id_50481482
- Flex System Information Center
<http://flexsystem.lenovofiles.com/help/index.jsp>
- Operating System Interoperability Guide
<https://lenovopress.com/osig>
- Flex System Interoperability Guide
<https://lenovopress.com/fsig>
- Lenovo Support Portal
<https://datacentersupport.lenovo.com/us/en/>
- Lenovo Data Center Solution Configurator
<https://dcsc.lenovo.com>

Related product families

Product families related to this document are the following:

- [Blade Servers](#)
- [ThinkSystem SN550 Server](#)

Notices

Lenovo may not offer the products, services, or features discussed in this document in all countries. Consult your local Lenovo representative for information on the products and services currently available in your area. Any reference to a Lenovo product, program, or service is not intended to state or imply that only that Lenovo product, program, or service may be used. Any functionally equivalent product, program, or service that does not infringe any Lenovo intellectual property right may be used instead. However, it is the user's responsibility to evaluate and verify the operation of any other product, program, or service. Lenovo may have patents or pending patent applications covering subject matter described in this document. The furnishing of this document does not give you any license to these patents. You can send license inquiries, in writing, to:

Lenovo (United States), Inc.
8001 Development Drive
Morrisville, NC 27560
U.S.A.
Attention: Lenovo Director of Licensing

LENOVO PROVIDES THIS PUBLICATION "AS IS" WITHOUT WARRANTY OF ANY KIND, EITHER EXPRESS OR IMPLIED, INCLUDING, BUT NOT LIMITED TO, THE IMPLIED WARRANTIES OF NON-INFRINGEMENT, MERCHANTABILITY OR FITNESS FOR A PARTICULAR PURPOSE. Some jurisdictions do not allow disclaimer of express or implied warranties in certain transactions, therefore, this statement may not apply to you.

This information could include technical inaccuracies or typographical errors. Changes are periodically made to the information herein; these changes will be incorporated in new editions of the publication. Lenovo may make improvements and/or changes in the product(s) and/or the program(s) described in this publication at any time without notice.

The products described in this document are not intended for use in implantation or other life support applications where malfunction may result in injury or death to persons. The information contained in this document does not affect or change Lenovo product specifications or warranties. Nothing in this document shall operate as an express or implied license or indemnity under the intellectual property rights of Lenovo or third parties. All information contained in this document was obtained in specific environments and is presented as an illustration. The result obtained in other operating environments may vary. Lenovo may use or distribute any of the information you supply in any way it believes appropriate without incurring any obligation to you.

Any references in this publication to non-Lenovo Web sites are provided for convenience only and do not in any manner serve as an endorsement of those Web sites. The materials at those Web sites are not part of the materials for this Lenovo product, and use of those Web sites is at your own risk. Any performance data contained herein was determined in a controlled environment. Therefore, the result obtained in other operating environments may vary significantly. Some measurements may have been made on development-level systems and there is no guarantee that these measurements will be the same on generally available systems. Furthermore, some measurements may have been estimated through extrapolation. Actual results may vary. Users of this document should verify the applicable data for their specific environment.

© Copyright Lenovo 2023. All rights reserved.

This document, LP1043, was created or updated on November 22, 2022.

Send us your comments in one of the following ways:

- Use the online Contact us review form found at:
<https://lenovopress.lenovo.com/LP1043>
- Send your comments in an e-mail to:
comments@lenovopress.com

This document is available online at <https://lenovopress.lenovo.com/LP1043>.

Trademarks

Lenovo and the Lenovo logo are trademarks or registered trademarks of Lenovo in the United States, other countries, or both. A current list of Lenovo trademarks is available on the Web at <https://www.lenovo.com/us/en/legal/copytrade/>.

The following terms are trademarks of Lenovo in the United States, other countries, or both:

Lenovo®
Bootable Media Creator
Flex System
Lenovo Services
ServerProven®
System x®
ThinkServer®
ThinkSystem®
TruDDR4
UpdateXpress System Packs
XClarity®

The following terms are trademarks of other companies:

Intel®, Intel Optane™, and Xeon® are trademarks of Intel Corporation or its subsidiaries.

Linux® is the trademark of Linus Torvalds in the U.S. and other countries.

ActiveX®, Hyper-V®, Microsoft®, PowerShell, Windows PowerShell®, Windows Server®, and Windows® are trademarks of Microsoft Corporation in the United States, other countries, or both.

SPECpower® is a trademark of the Standard Performance Evaluation Corporation (SPEC).

Other company, product, or service names may be trademarks or service marks of others.